

EL2001 Hot Sheet

System PN 53323_01 (Mach 2)

Balboa Instruments

System Model # EL2-EL2001-YCAH

Base PCBA PN

EL2001 – 53414

Base Panels

ML 700 – PN 52649

ML 900 – PN 52654

The ML 200 and ML 400 Panels are compatible, but may require Aux panels for adequate functionality.



Circuit Board Configuration

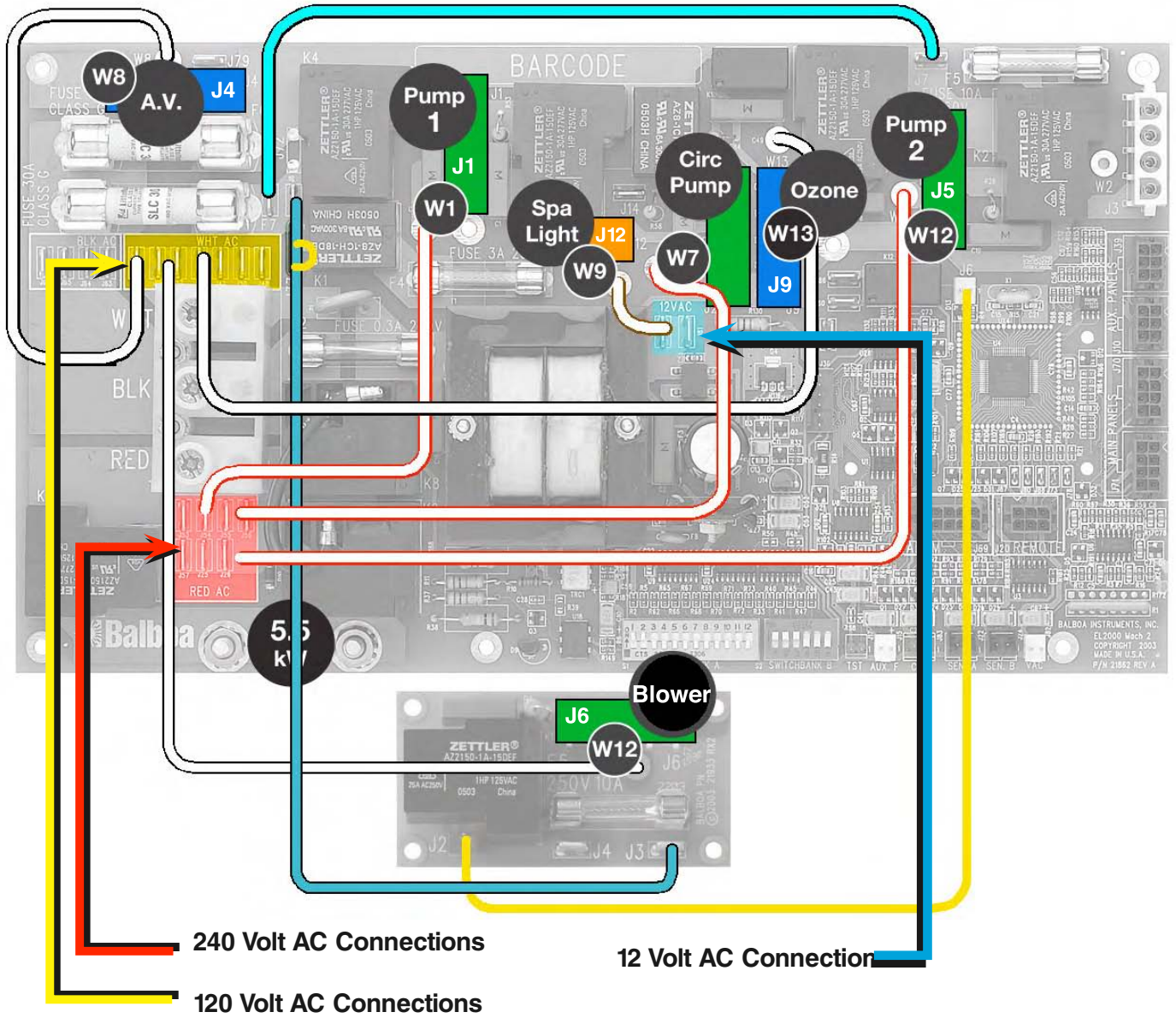

Circuit Board Layout

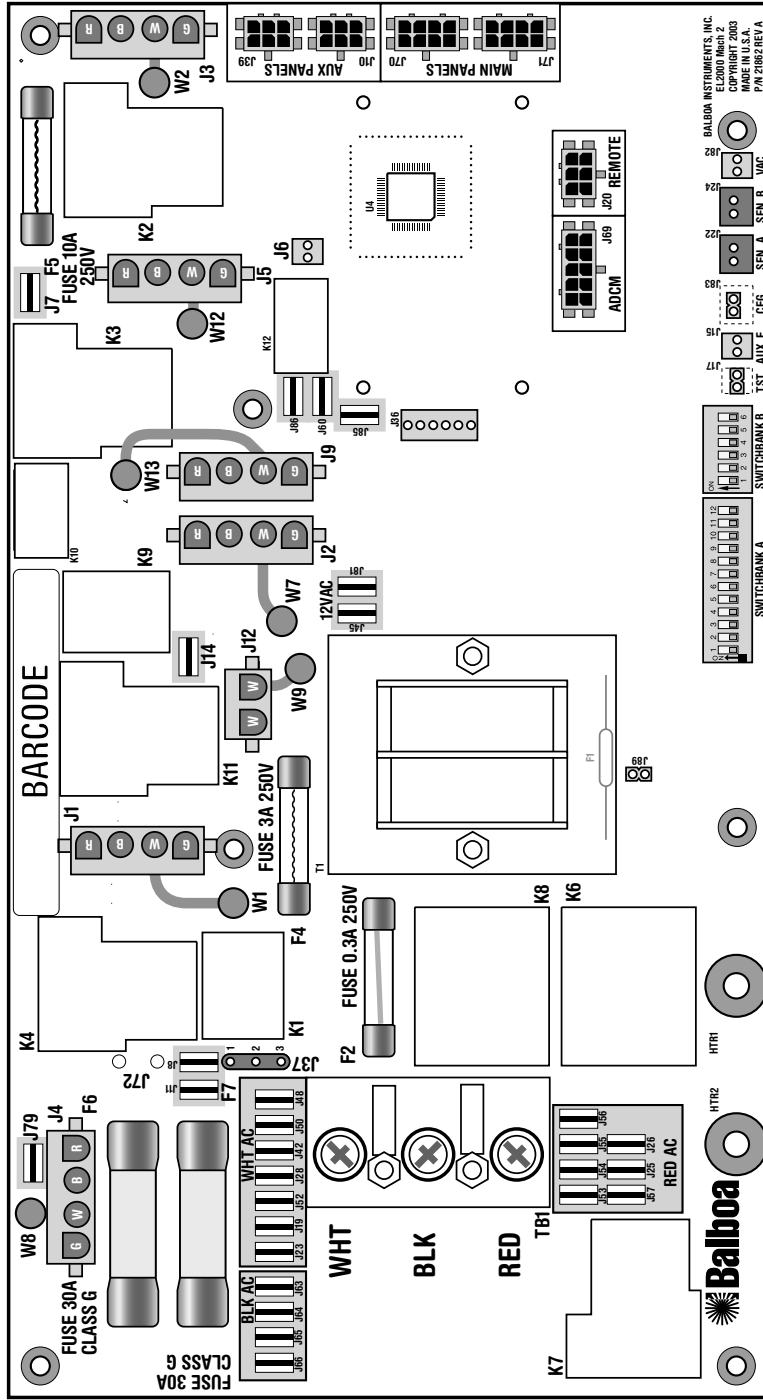

- J1 & W1 . . . Pump 1
- J2 & W7 . . . Circ Pump
- J6 & W12 . . . Blower
- J4 & W8 . . . A. V.
- J5 & W12 . . . Pump 2
- J9 & W13 . . . Ozone
- J12 & W9 . . . Light

Optional Aux Relay Board 120V (W12 - J50)

J3 to Black AC on Main Board (J11)

J to J60 on Main Board (EXT - near Switchbank A)

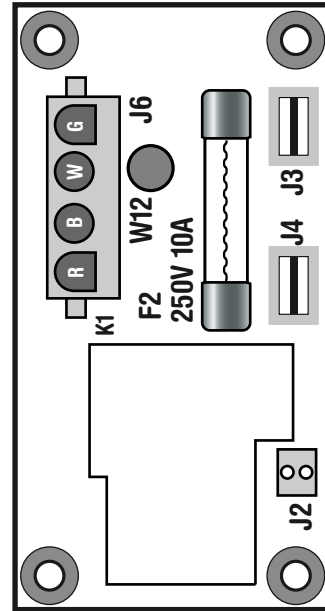

DIP Switches and Jumpers

Switchbank A

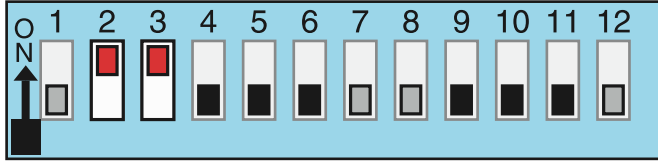

- A1, Test Mode OFF
- A2, High Amp
- A3, Filter by Duration
- A4, 12 Hr Time
- A5, Degrees F
- A6, Short Timeouts
- A7, Cleanup Cycle OFF
- A8, 1Hr O₃ Disable OFF
- A9/A10, No Circ Pump
- A11, O₃ w/P1 low
- A12, Memory ON

Switchbank B

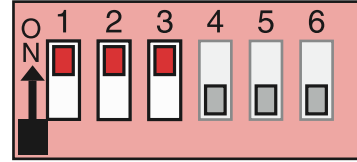

- B1, Pump 2 1-Speed
- B2, Pump 2 Enabled
- B3, Blower Enabled
- B4, No Fiber/Wheel
- B5, N/A
- B6, Panel Scrunching OFF

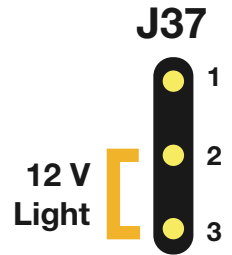

DIP Switch Key

- A 1 Test Mode (normally Off)
 - A 2 In "ON" position, all high-speed pumps/blower can run with Heater
..... In "OFF" position, no high-speed pumps or blower can run with Heater
 - A 3 In "ON" position, filter cycles are programmed by duration as opposed to start and end times
 - A 4 Displays time in 24 hours (military time) – in ON position.
..... Displays 12 hour time when OFF
 - A 5 Celsius (ON) or Fahrenheit (OFF) Temperature Display
 - A 6 Pump timeout settings (15 minutes / 2 hr for P1 low (Off) or
..... 30 minutes / 4 hr for P1 low (On))
 - A 7 Cleanup Cycle – 30 min after spa use/timeout,
..... P1-low & Ozone run for 1 hour.
 - A 8 Ozone Suppression for one hour after pump/blower button press
 - A9 and A 10 See **Figure 2** for Circ Pump Behavior settings
 - A 11 Ozone in Filter Cycle only (non-circ mode)
..... One-Speed Pump 1 (in any circ mode)
..... (Refer to **Figure 2**)
 - A 12 Persistent memory reset
..... (used when spa is powering up)
-
- B 1 Single-speed Pump 2
 - B 2 Pump 2 Enable
 - B 3 Blower Enable with pump 2 low relay
 - B 4 fiber and Wheel instead of Spa Light (non-circ only)
 - B 5 Pump 3 enable (Jets 3 replaces blower on Aux panel)
 - B 6 ML 900 scrunching - ML550 / 700 Jets 3 replaces Blower

A9	A10	Circ Pump Behavior
OFF	OFF	No Circ Pump
ON	OFF	24 Hr
OFF	ON	24 Hr w/3° Shut-Off
ON	ON	Acts like P1 low (Filter Cycles, Polls)

Figure 2

J37 Jumper on Pin 1 and 2 will power one leg of J9 (Spa Light) at 120 Volts AC.

Jumper on Pin 2 and 3 will power one leg of J9 (Spa Light) at 12 Volts AC.

Note: W9 controls voltage on the other leg of J9 and must be set for the same voltage.

Ozone Connections

First, configure the EL Circuit Board to deliver the desired voltage to the on-board connector (J9). Connect the W-13 wire to either White AC (120V) or Red AC (240V) to set the voltage.

The pin next to ground determines voltage on these connectors. Ground is typically the bottom pin of the white connector (if the flat sides of the top and bottom holes are to the left and the heater connections are on the bottom edge of the board).

The pin next to the bottom (ground) pin of J9 is fed by W-13 and sets the voltage in the connector.

If the board is set up to operate a 120V ozone generator, the connector on the ozone generator is likely to be configured correctly, but should be compared to the illustration below.

If a 240V ozone generator is required, be sure the red wire in the ozone cord is positioned in the connector next to the green ground wire as described below.

Note: A special tool is required to remove the pins from the connector body once they are snapped in place. Check with your Balboa Account Manager for information on purchasing a pin-removal tool.

Ozone connector configuration for 120V 60Hz

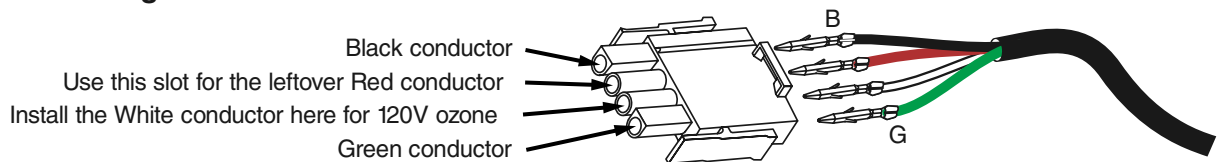

Ozone connector configuration for 240V 60Hz

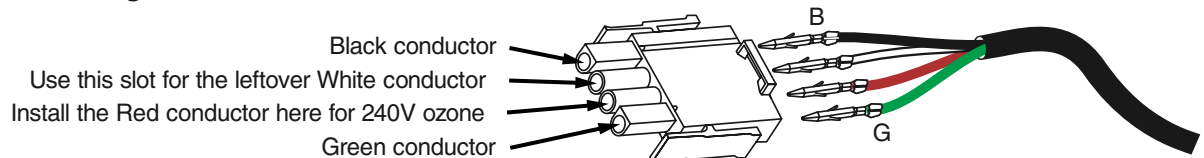

Panel Configuration

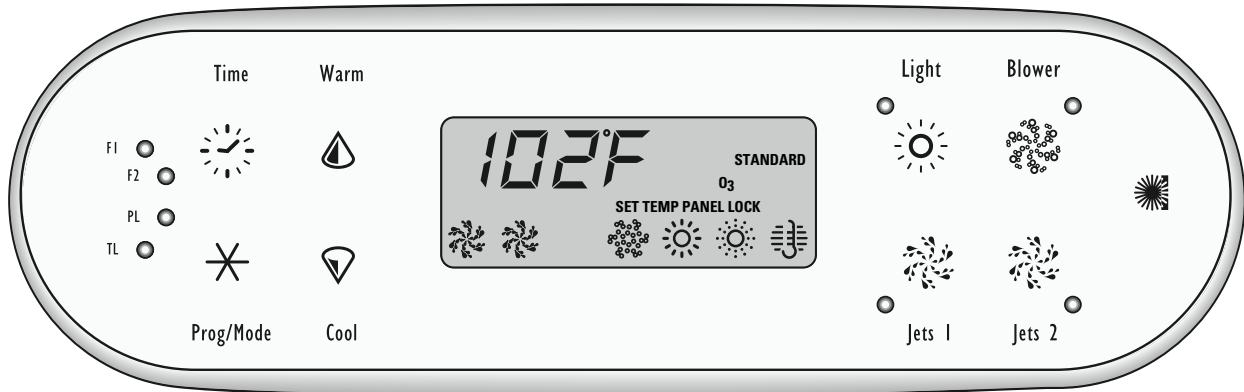

ML 700
PN 53649

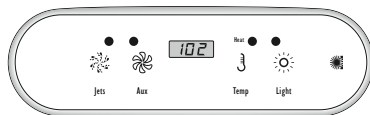

ML 400
PN 52684



ML 200
PN 52958

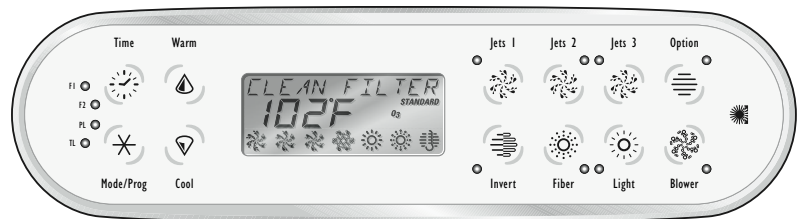

ML 900
PN 52654

Auxiliary panels are available in the following configurations:

Infrared Remote (Dolphin) which has a separate connector on the board.

- 4-Button
- 2-Button
- 1-Button

Configuration of the 4-Button and 2-Button Aux Panels can be done for custom applications.

1-button Aux panels are available in 4 different versions.

There are two Aux Panel connectors on the board.

Panel "Scrunching" on the ML 900 (requires custom panel overlays)

With DIP switch B6, unused buttons on an ML 900 can be "scrunched" in a custom configuration or the unused positions can be left blank.

Scrunching moves the buttons in a counter-clockwise direction from the bottom row to the top row, on the right side of the display. The result is that all missing buttons or gaps appear on the bottom row, just to the right of the display.

Note: Some button positions MUST be used in order to perform certain functions. For instance, the Jets 2 button and the Blower button are used in certain button press combinations, and need to be available to a user, even if they are labeled with a different name.

See reference cards for details.