

# VS500Z Hot Sheet

## Balboa Instruments System PN 54368-01

System Model # VSP-VS500Z-CCAH  
Software Version # 35  
EPN # 1801

Base PCBA - PN 54369-01  
PCB VS500Z - PN 22972 Rev C or D

### Base Panels

Mini – PN 52144

Lite Digital – PN 54094

Lite Duplex – PN 51676



# Basic System Features and Functions

## Power Requirements

- 120/240VAC, 60Hz, 16/32A, Class A GFCI-protected service (Circuit Breaker rating = 20/40A max.)
- 4 wires (hot, hot, neutral, ground)

## System Outputs (As Configured)

- 120V Pump 1, 2-Speed
- 120V Circ Pump
- 120V Ozone
- 12V Spa Light
- 120V AV (Stereo)
- 240V 5.5kW Heater

## Additional Options

- Full Feature Dolphin Remote and Spa-only Dolphin Remote  
Connects to terminal J1 or J2
- Ozone Generator  
Connects to terminal J29
- MoodEFX Lighting  
Connects to Spa Light terminal J20
- FiberEFX Lighting  
Connects to Spa Light terminal J20
- Stereo System  
Connects to A.V. terminal J50

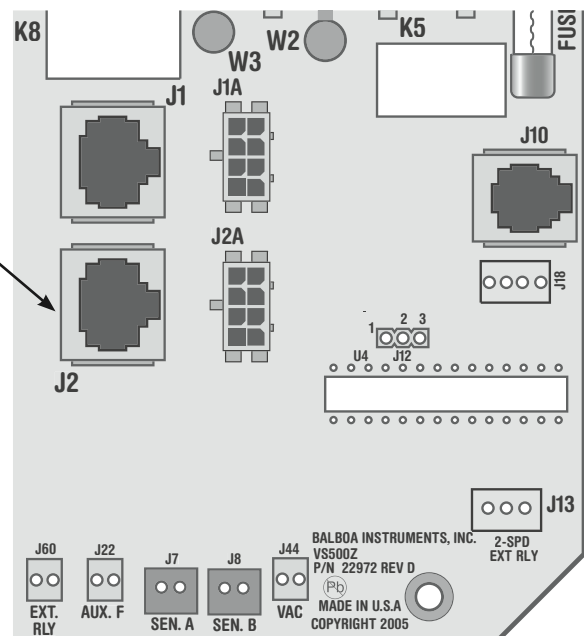

# Wiring Configuration

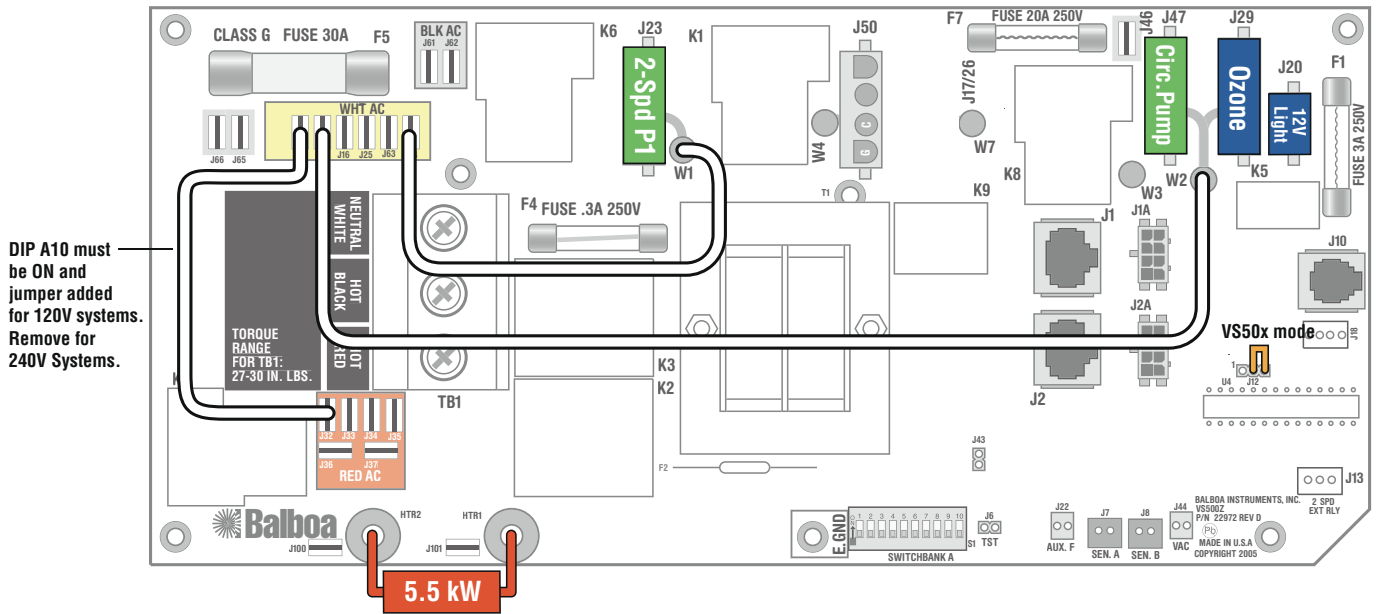

### Wiring Color Key

- 120 Volt Connections
- 240 Volt Connections
- Black AC Jumpers
- 12 Volt Connections
- Relay Control Wires

### Connector Key

- Typically Line voltage
  - Typically Line voltage for 2-speed pumps
  - Common, typically 240V or 120V per W wire
  - Ground
- Note flat sides in connector

PCB Revision	History
C	Production Release
D	Added Red AC connections J36 & J37; Added Aux Heater connections J100 & J101

# Configuration Options

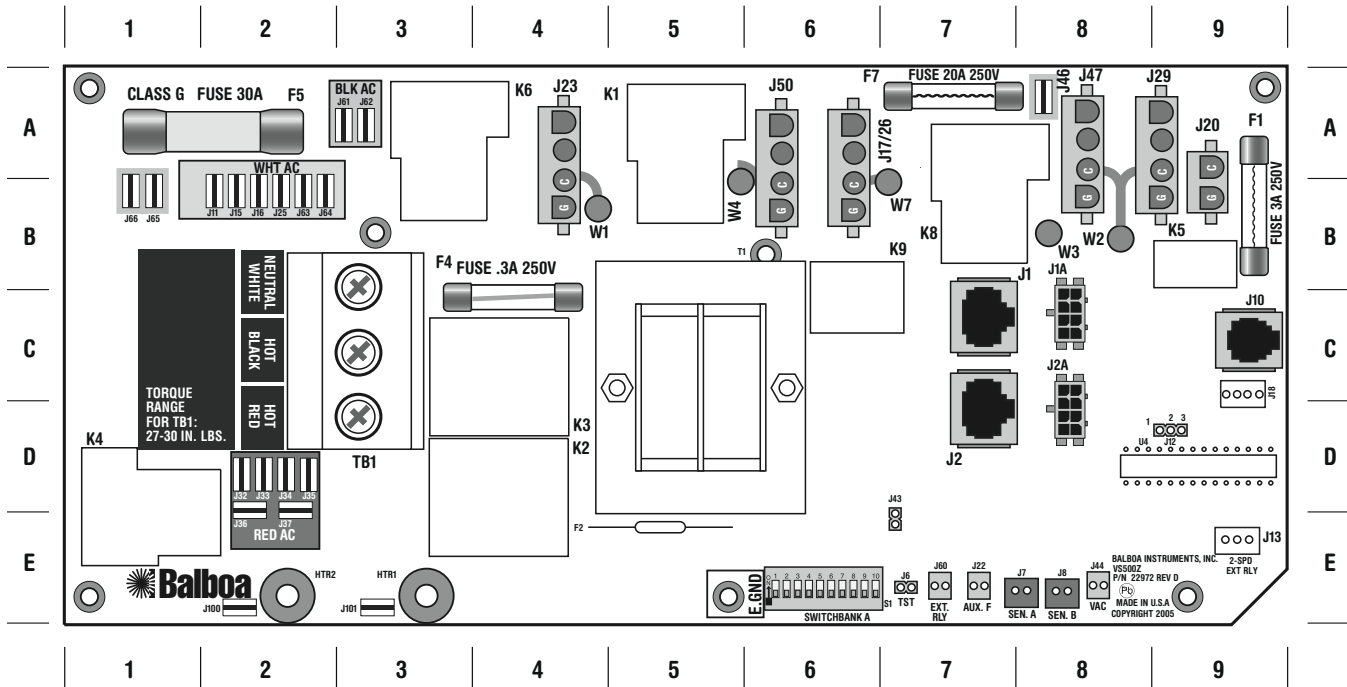

## Output Features

## Quadrant

J23	+ W1	- 2-Speed Pump 1	4-A
		- OR 1-Speed Pump 1 with DIP Switch A5	
J50	+ W4	- Audio Visual - always hot, no relay	6-A
J17/26	+ W7	- 1-Speed Blower (W3 to J46)	6-B
		- OR Single-Speed Pump 2 or Pump 3 (W3 to J62)	
J47	+ W2	- Circ Pump	8-A
J29	+ W2	- Ozone (Same voltage as Circ Pump, if used)	9-A
		- Note X-03 option board for retro fit	
J20		- Spa Light (12V only)	9-A

System can be factory configured for either a Duplex Topside Panel, a Serial Standard Panel, or a Digital Deluxe Panel.

Note: Some panels styles are not available depending on system configuration. Consult your Balboa product representative for details.

120V Conversion Option - Add jumper from Red AC (J32) to White AC (J11) and set DIP switch A10 to ON.

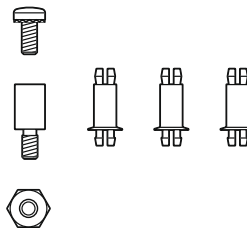

## X-Mount P

PN 53933

Used for mounting any Expander Board in a plastic enclosure.

Standoffs attach to heater mounting bracket.

# Expander Options

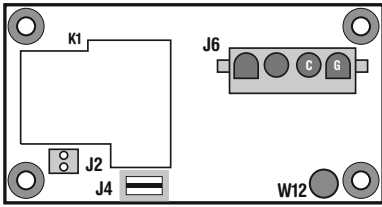

**X-P** **PN 53544**  
Used for a 1-speed Pump output.

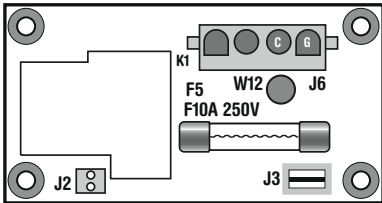

**X-B** **PN 53310**  
Used for a Blower output ONLY.

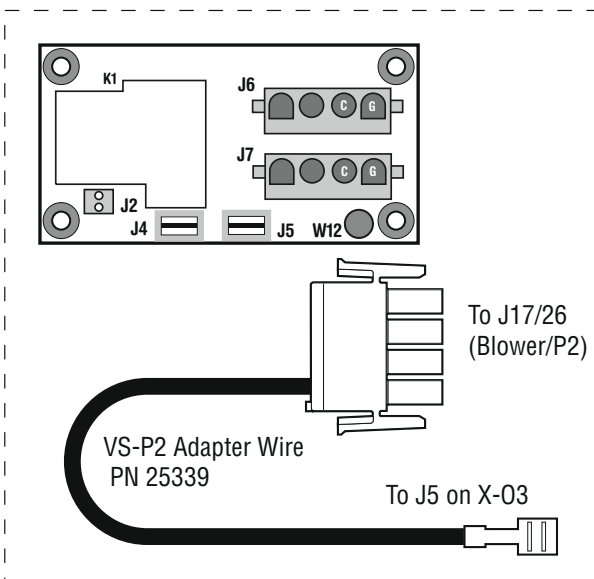

**X-2SP Kit** **PN 53913**  
Adapter PN 25339 is used in conjunction with an X-03 to run a 2-speed pump 2. No Blower is available when this kit is used.

- J4 connects to Black AC (3-A) using J61 or J62 on main board.
- Connect 2-speed pump to J7 on X-03.

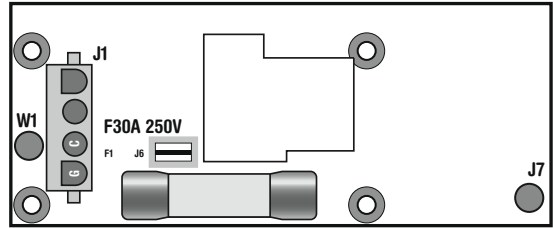

**X-P231** **PN 53681**  
Can replace the X-P in cases where branch circuit protection is needed for high amperage devices that would over-burden power input fuse F5 (1-A) on the main PCBA.

- J6 on the X-P231 connects directly to Black AC by using J66 or J65 on the main board (1-B).
- Connect J7 wire on the X-P231 to **J60** on the main board (7-E).
- Connect W1 on the X-P231 to Red AC on the main board (2-D).

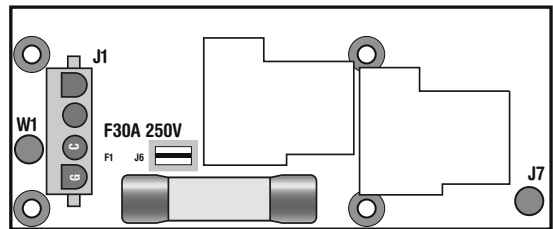

**X-P332** **PN 55137**  
Used for an additional 2-speed Pump output.

- J6 on the X-P332 connects directly to Black AC by using J66 or J65 on the main board (1-B).
- Connect J7 wire on the X-P332 to **J13** on the main board (9-E).
- Connect W1 on the X-P332 to Red AC on the main board (2-D).

**NOTE Regarding J12 (Quadrant 9-D):**

When J12 on the Main Board is jumpered on pins 2 & 3, the system is in VS50xZ compatibility mode.

If J12 on the Main Board is jumpered on pins 1 & 2, the system is in VS51xZ/VS5xxSZ/VS5xxDZ compatibility mode.

# DIP Switches and Jumpers

**SSID #**  
100  
61  
35

## Switchbank A

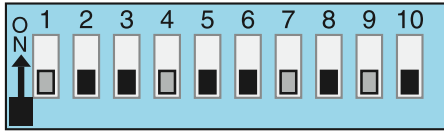

- |                              |                                 |
|------------------------------|---------------------------------|
| <b>A1, Test Mode OFF</b>     | <b>A6, 60 Hz</b>                |
| <b>A2, U, J, T, L</b>        | <b>A7, Mode changes allowed</b> |
| <b>A3, Duplex Panel</b>      | <b>A8, Degrees F</b>            |
| <b>A4, Aux Freeze</b>        | <b>A9, Circ Pump OFF</b>        |
| <b>A5, 1-speed P1 w/Circ</b> | <b>A10, High Amp mode</b>       |

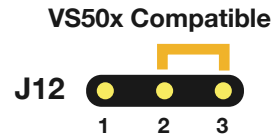

### DIP Switch Key

- A1 ..... Test Mode (normally Off)
- A2 ..... In "ON" position, Button layout will be: Jets, Light, Down, Up  
..... In "OFF" position, Button layout will be: Unused, Jets, Temp, Light
- A3 ..... In "ON" position, use Mini Panel  
..... In "OFF" position, use Digital Duplex or Light Duplex panel
- A4 ..... Aux Freeze (must be OFF)
- A5 ..... In "ON" position, Two-speed pump 1  
..... In "OFF" position, One-speed pump 1 (A9 must be On and a circ pump installed)
- A6 ..... In "ON" position, 50Hz operation  
..... In "OFF" position, 60Hz operation
- A7 ..... In "ON" position, Standard mode only  
..... In "OFF" position, Std/Ecn/Sleep mode changes allowed
- A8 ..... In "ON" position, temperature is displayed in degrees Celsius  
..... In "OFF" position, temperature is displayed in degrees Fahrenheit
- A9 ..... In "ON" Position, 24 Hour Circ Pump with 3°F shut off  
..... In "OFF" position, no circ pump
- A10 ..... In "ON" Position, heater is disabled while any high-speed pump or blower is running (low amperage mode)  
..... In "OFF" position, heater can run while any/all high-speed pumps or blowers are running (high amperage mode)

\* No blower or second pump available on VS500Z models. If additional output is required, use VS501Z or higher.

### Jumper Key

- J12** Jumper on Pin 1 and 2 will enable VS51x/VS5xxS/VS5xxD compatibility mode.  
Jumper on Pin 2 and 3 will enable VS50x compatibility mode (Do not use with Serial or Deluxe Panels).
- J43** When jumper is placed on 2 pins during power-up, system will reset persistent memory.  
Leave on 1 pin only to enable persistent memory feature.

# Ozone Connections

**Ozone Connector Voltage:** The VS500Z circuit board is factory configured to deliver a preset voltage (120V or 240V) to the on-board ozone connector (J29). See the ratings table on the wiring diagram attached to the cover of the enclosure for the configured voltage. For 240V output W2 connects to Red AC and for 120V output W2 connects to White AC.

The voltage to the ozone connector can be changed in the field if required. W2 just needs to be set for the required voltage.

**WARNING: Changing the voltage of the ozone connector also effects the voltage supplied to the circ pump connector (J47). Any equipment controlled by that connector may be damaged if the wrong voltage is selected.**

**Balboa Ozone Generator:** If the board is set up to operate a 120V ozone generator, the connector on the ozone generator is likely to be configured correctly, but should be compared to the illustration below.

If a 240V ozone generator is required, be sure the red wire in the ozone cord is positioned in the connector next to the green ground wire as described below.

*Note: A special tool is required to remove the pins from the connector body once they are snapped in place. Check with your Balboa Account Manager for information on purchasing a pin-removal tool.*

## Balboa Ozone connector configuration for 120V 60Hz

- Line - Black conductor
- Use this slot for the leftover Red conductor
- Common - Install the White conductor here for 120V ozone
- Ground (Green) conductor

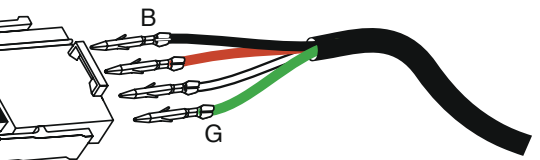

Flat sides of sockets as shown

## Balboa Ozone connector configuration for 240V 60Hz

- Line - Black conductor
- Use this slot for the leftover White conductor
- Common - Install the Red conductor here for 240V ozone
- Ground (Green) conductor

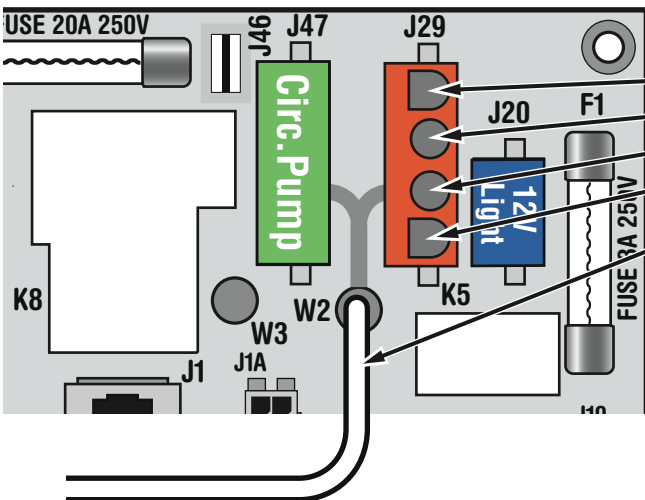
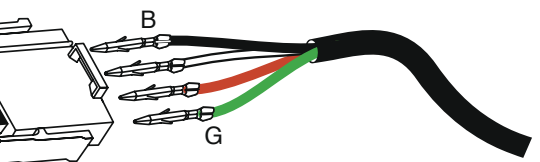

- Line - Black conductor
- Use this slot for the leftover conductor
- Common - Red for 240V or White for 120V ozone (See W2 wire)
- Ground (Green) conductor
- W2 wire determines voltage

# Duplex Panel Configurations



Mini Panel

PN 52144 with Overlay PN 11095

- Connects to Main Panel terminal J1

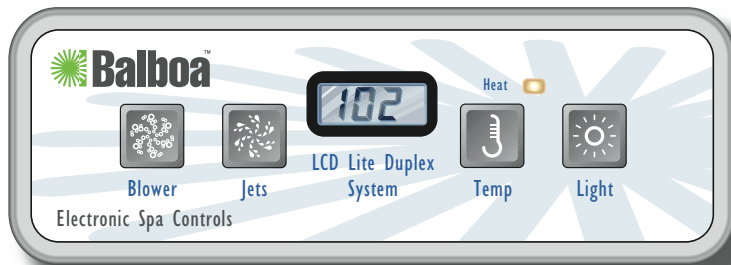

Lite Digital

PN 54094 with Overlay PN 10669

- Connects to Main Panel terminal J1

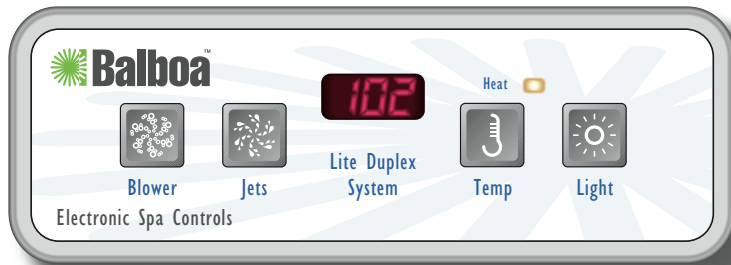

Lite Duplex

PN 51676 with Overlay PN 10671

- Connects to Main Panel terminal J1