

VS500Z Hot Sheet

Balboa Instruments System PN 54368-02

System Model # VSP-VS500Z-CCAH

Software Version # 38

EPN # 2570

Base PCBA - PN 54369-02

PCB VS500Z - PN 22972 Rev C or D

Base Panels

VL200 (Mini bath) – PN 52144

VL401 (Lite Duplex) – PN 54094

VL402 (Duplex Digital) – PN 51676



System Revision History

System PN	EPN	Date	Requested By	Changes Made
54368	1801	05.09.2006	Balboa	New system
54368-01	1801	08.01.2006	Balboa	Software update to v35
54368-02	2570	09.24.2007	Balboa	Software update to v38

Basic System Features and Functions

Power Requirements

- 120/240VAC, 60Hz, 16/32A, Class A GFCI-protected service (Circuit Breaker rating = 20/40A max.)
- 3 or 4 wires [hot, hot (optional), neutral, ground]

System Outputs

Setup 1 (As Manufactured)

- 240V Pump 1, 2-Speed
- 240V Ozone *
- 12V Spa Light
- 240V AV (Stereo)
- 240V 5.5kW Heater **

Setup 2

- 120V Pump 1, 2-Speed
- 120V Ozone *
- 12V Spa Light
- 120V AV (Stereo)
- 240V 5.5kW Heater **

Optional Devices

- 240V Circ Pump *

Optional Devices

- 120V Circ Pump *

* Ozone and Circ Pump must be same voltage.

** Heater wattage is rated at 240V. When running 120V to heater, output is approximately 25%.

Additional Options

- Full Feature Dolphin Remote and Spa-only Dolphin Remote
- IR Receiver Module
Connects to terminal J1 or J2
- MoodEFX Lighting
Connects to Spa Light terminal J20
- FiberEFX Lighting
Connects to Spa Light terminal J20

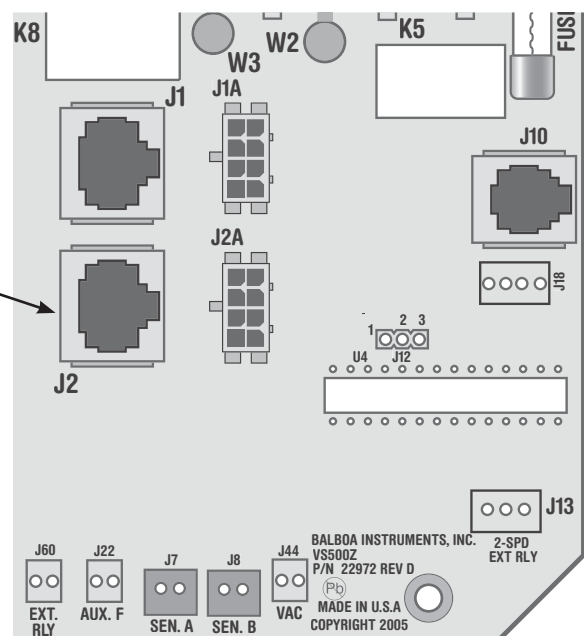

Basic System Features and Functions

Any time you change a DIP Switch, other than A1, you must reset Persistent Memory for your new DIP Switch Settings changes to take effect. If you do not reset Persistent Memory, your system may function improperly.

To reset Persistent Memory:

- Power down by disconnecting power source from spa.
- Put a jumper across J43, covering both pins. (See illustration below)
- Power up by connecting power source to spa.
- Wait until “P” is displayed on your panel.
- Power down again.
- Remove jumper from J43 (May also move to cover 1 pin only)
- Power up again.

About Persistent Memory and Time of Day Retention:

This system uses memory that doesn't require a battery to store a variety of settings. What we refer to as Persistent Memory stores the filter settings, the set temperature, and the heat mode.

Persistent Memory is not used for Time of Day. Only models with a Serial Deluxe panel installed (VS5xxDZ and GS5xxDZ) can display the time. However, during power loss to the spa, the system will lose the correct time, and reset to 12:00 PM when power is restored.

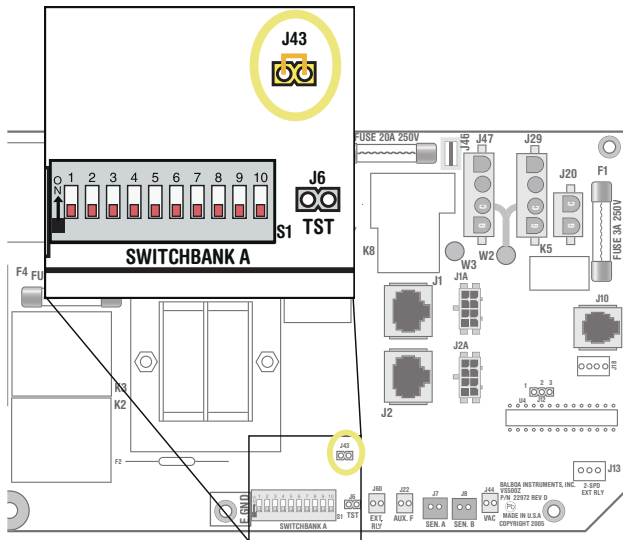

J43 on VS5xxZ and VS300 Series Main Board Shown.

Power Up Display Sequence

Upon power up, you should see the following on the display:

- Three numbers in a row, which are the SSID (the System Software ID). The third display of these numbers is the Software Version, which should match the version of your system. For example, if these three numbers are 100 67 38, that is a VS511SZ at version 38.
- Displayed next is: “24” (indicating the system is configured for a heater between 3 and 6 kW) or “12” (indicating the system is configured for a heater effectively* between 1 and 3 kW). “24” should appear for all VS models running at 240VAC. “12” should appear for all VS models running at 120VAC, as well as all GS models. (*A heater which is rated at 4 kW at 240VAC will function as a 1 kW heater at 120VAC.)
- “P” will appear to signal the start of Priming Mode.

At this point, the power up sequence is complete. Refer to the Reference Card for the VS or GS System model of your spa for information about how the spa operates from this point on, including how to adjust the Time of Day if using a Serial Deluxe style panel.

Wiring Configuration and DIP Settings

Setup 1 (As Manufactured)

- 240V Pump 1, 2-Speed
- 240V AV (Stereo)
- 240V Ozone
- 240V 5.5kW Heater
- Duplex Main Panel
- 240V Circ Pump (Optional)

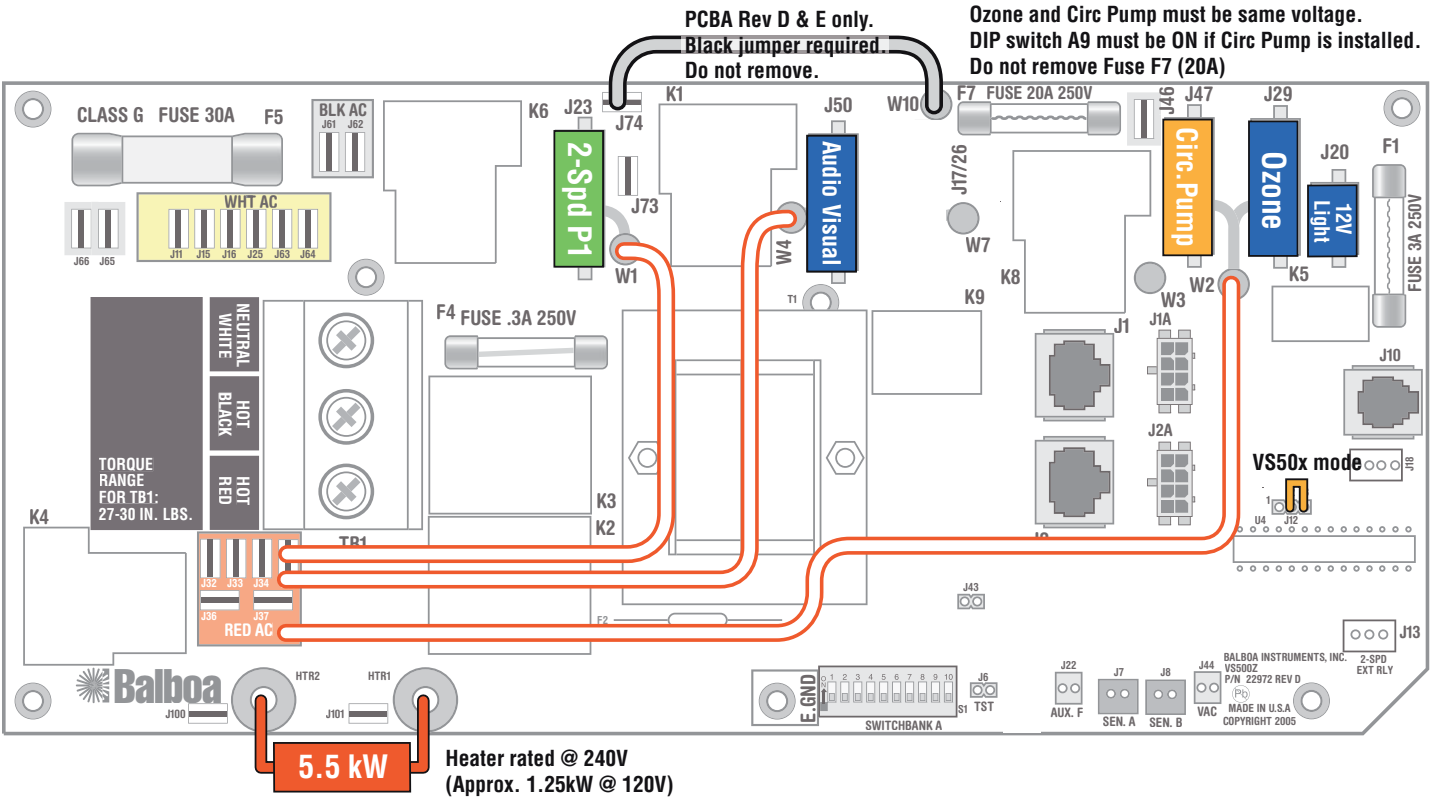

WARNING: Main Power to system should be turned OFF BEFORE adjusting DIP switches.
WARNING: Persistent Memory (J43) must be RESET to allow new DIP switch settings to take effect. (See Persistent Memory page)

SSID #

100
61
38

Switchbank A

A1, Test Mode OFF
A2, Un, P1, TE, LT
A3, Duplex Panel
A4, Aux Freeze
A5, NA when A9 is OFF
A6, 60 Hz
A7, Mode changes allowed
A8, Degrees F
A9, Circ Pump OFF
A10, High Amp mode

VS50x Compatible

J12

J43

Memory Reset

Wiring Color Key

- 120 Volt Connections
- 240 Volt Connections
- Black AC Jumpers
- 12 Volt Connections
- Relay Control Wires

Board Connector Key

- 1 Typically Line voltage
- 2 Typically Line voltage for 2-speed pumps
- 3 Neutral (Common)
- 4 Ground

Note flat sides in connector

Panel Button Assignments

1=Unused 3=Temp
2=Pump 1 4=Light

Panel Button Positions

Wiring Configuration and DIP Settings

Setup 2

- 120V Pump 1, 2-Speed
- 120V Ozone
- 12V Spa Light
- 120V AV (Stereo)
- 240V 5.5kW Heater
- Duplex Main Panel
- 120V Circ Pump (Optional)

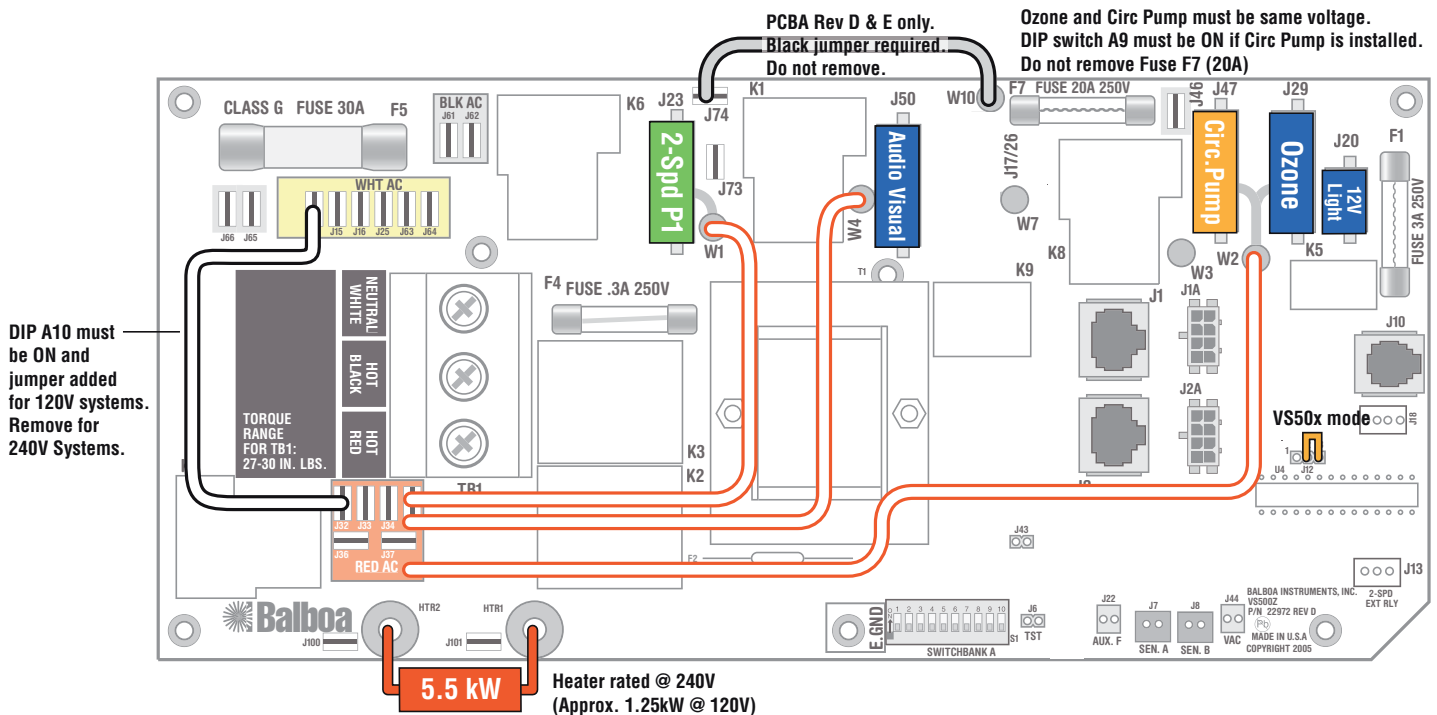

WARNING: Main Power to system should be turned OFF BEFORE adjusting DIP switches.
WARNING: Persistent Memory (J43) must be RESET to allow new DIP switch settings to take effect. (See Persistent Memory page)

SSID #
 100
 61
 38

Switchbank A

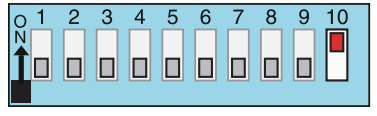

- | | |
|-----------------------|--------------------------|
| A1, Test Mode OFF | A6, 60 Hz |
| A2, Un, P1, TE, LT | A7, Mode changes allowed |
| A3, Duplex Panel | A8, Degrees F |
| A4, Aux Freeze | A9, Circ Pump OFF |
| A5, NA when A9 is OFF | A10, Low Amp mode |

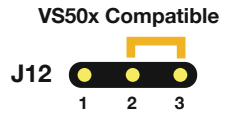

- Wiring Color Key**
- 120 Volt Connections (black line)
 - 240 Volt Connections (red line)
 - Black AC Jumpers (black line)
 - 12 Volt Connections (blue line)
 - Relay Control Wires (yellow line)

- Board Connector Key**
- Typically Line voltage
 - Typically Line voltage for 2-speed pumps
 - Neutral (Common)
 - Ground
- Note flat sides in connector

- Panel Button Assignments**
- | | |
|----------|---------|
| 1=Unused | 3=Temp |
| 2=Pump 1 | 4=Light |

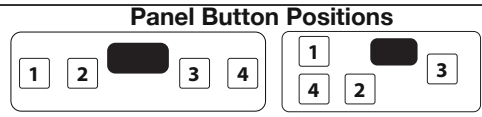



DIP Switches and Jumpers Definitions

SSID 100 61 38

Base Model VS500Z

DIP Switch Key

- A1 Test Mode (normally OFF)
- A2 "ON" position: Button layout will be: Pump 1, Light, Temp Down, Temp Up *
"OFF" position: Button layout will be: Unused, Pump 1, Temp, Light
- A3 "ON" position: use Mini Panel * 
"OFF" position: use Lite Duplex or Digital Duplex panel 
- A4 Aux Freeze (must be OFF)
- A5 Disabled when A9 is OFF
"ON" position: Two-speed pump 1
"OFF" position: One-speed pump 1 (A9 must be On and a Circ Pump installed)
- A6 "ON" position: 50Hz operation
"OFF" position: 60Hz operation
- A7 "ON" position: Standard mode only
"OFF" position: Std/Ecn/Sleep mode changes allowed
- A8 "ON" position: temperature is displayed in degrees Celsius
"OFF" position: temperature is displayed in degrees Fahrenheit
- A9 "ON" position: 24 Hour Circ Pump with 3°F shut off, Ozone runs with Circ Pump
"OFF" position: no Circ Pump, Ozone runs with Pump 1-low during filter cycles only
- A10 "ON" position: heater is disabled while any high-speed pump is running (low amperage mode)
"OFF" position: heater can run while any/all high-speed pumps are running (high amperage mode)

* Panels with button layout  are not compatible when A2 or A3 is ON.

Note: No blower or second pump available on VS500Z model. If additional output is required, use VS501Z or higher.

Jumper Key

J12 **Factory set. DO NOT MOVE.**

Jumper must be on Pins 1 and 2 for VS51xZ/VS5xxSZ/VS5xxDZ software.

Jumper must be on Pins 2 and 3 for VS50xZ software.

J43 When jumper is placed on 2 pins during power-up, system will reset persistent memory.

Leave on 1 pin only to enable persistent memory feature.

WARNING:

- Setting DIP switches incorrectly may cause abnormal system behavior and/or damage to system components.
- Refer to Switchbank illustration on Wiring Configuration page for correct settings for this system.
- Contact Balboa if you require additional configuration pages added to this hot sheet.

Panel Button Positions

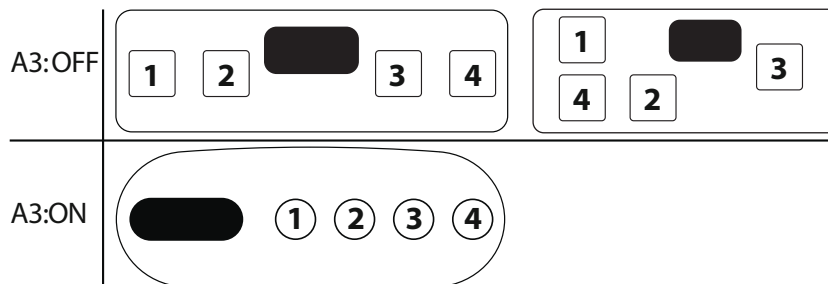

Panel Button Assignments

A2:OFF	1=Unused 2=Pump 1	3=Temp 4=Light
A2:ON	1=Pump 1 2=Light	3=Temp Down 4=Temp Up

Ozone Connections

Ozone Connector Voltage: The VS500Z circuit board is factory configured to deliver a preset voltage (120V or 240V) to the on-board ozone connector (J29). See the ratings table on the wiring diagram attached to the cover of the enclosure for the configured voltage. For 240V output W2 connects to Red AC and for 120V output W2 connects to White AC.

The voltage to the ozone connector can be changed in the field if required. W2 just needs to be set for the required voltage.

WARNING: Changing the voltage of the ozone connector also effects the voltage supplied to the circ pump connector (J47). Any equipment controlled by that connector may be damaged if the wrong voltage is selected.

Balboa Ozone Generator: If the board is set up to operate a 120V ozone generator, the connector on the ozone generator is likely to be configured correctly, but should be compared to the illustration below.

If a 240V ozone generator is required, be sure the red wire in the ozone cord is positioned in the connector next to the green ground wire as described below.

Note: A special tool is required to remove the pins from the connector body once they are snapped in place. Check with your Balboa Account Manager for information on purchasing a pin-removal tool.

Balboa Ozone connector configuration for 120V 60Hz

- Line - Black conductor
- Use this slot for the leftover Red conductor
- Common - Install the White conductor here for 120V ozone
- Ground (Green) conductor

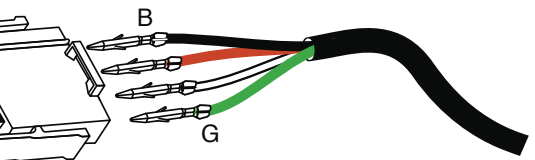

Flat sides of sockets as shown

Balboa Ozone connector configuration for 240V 60Hz

- Line - Black conductor
- Use this slot for the leftover White conductor
- Common - Install the Red conductor here for 240V ozone
- Ground (Green) conductor

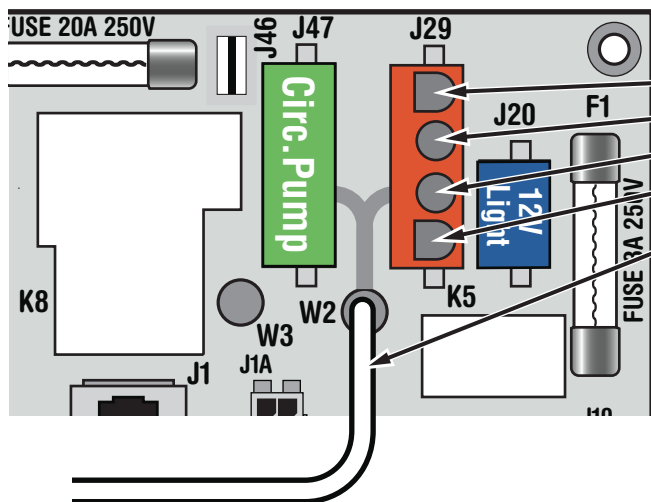
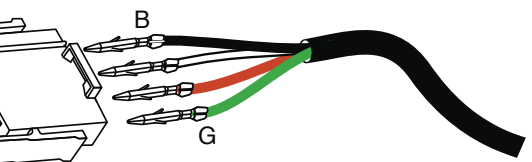

- Line - Black conductor
- Use this slot for the leftover conductor
- Common - Red for 240V or White for 120V ozone (See W2 wire)
- Ground (Green) conductor
- W2 wire determines voltage

Duplex Panel Configurations



Switchbank A

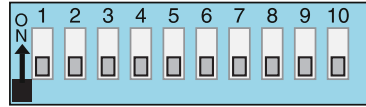

A3 must be OFF

VL401 (Lite Digital)

PN 54135 with Overlay PN 10839

- Connects to Main Panel terminal J1



Switchbank A

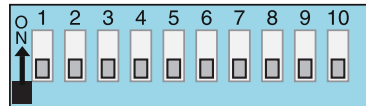

A3 must be OFF

VL403 (LED Lite Digital)

PN 54105-01 with Overlay PN 10753

- Connects to Main Panel terminal J1
- Not compatible with some configurations; not recommended for new designs



Switchbank A

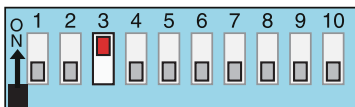

A3 must be ON

VL200 (Mini Panel)

PN 52487 with Overlay PN 11219

- Connects to Main Panel terminal J1

SETUPS 1-2

OPTIONAL PANEL