

VS510SZ Hot Sheet

Balboa Instruments System PN 54371

System Model # VSP-VS510SZ-DCAH

Software Version # 23

EPN # 1801

Base PCBA - PN 54372

PCB VS500Z - PN 22972 Rev C or D

Base Panels

Serial Standard – PN 53189



Basic System Features and Functions

Power Requirements

- 240VAC, 60Hz, 40A, Class A GFCI-protected service (Circuit Breaker rating = 50A max.)
- 4 wires (hot, hot, neutral, ground)

System Outputs (As Configured)

- 240V Pump 1, 2-Speed
- 240V Pump 2, 2-Speed
- 240V Blower
- 120V Circ Pump
- 120V Ozone
- 12V Spa Light
- 240V 5.5kW Heater

Additional Options

- Full Feature Dolphin Remote and Spa-only Dolphin Remote
Connects to terminal J1 or J2
- IR Receiver Module
Connects to terminal J29
- Ozone Generator
Connects to terminal J29
- MoodEFX Lighting
Connects to Spa Light terminal J20
- FiberEFX Lighting
Connects to Spa Light terminal J20
- Stereo System
Connects to A.V. terminal J50

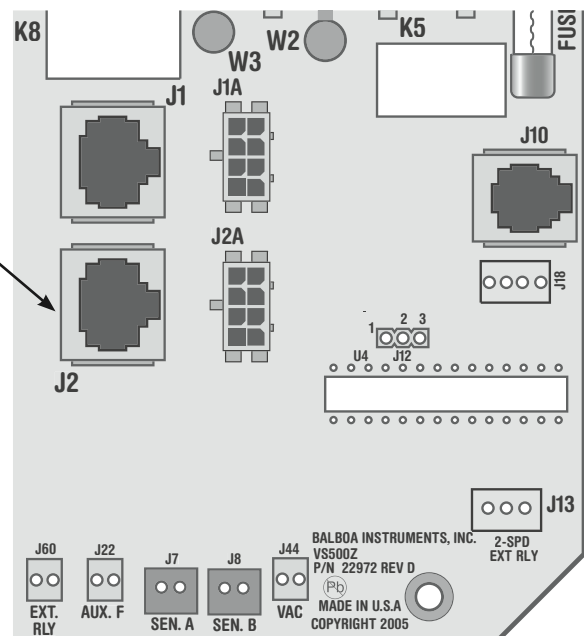

Wiring Configuration

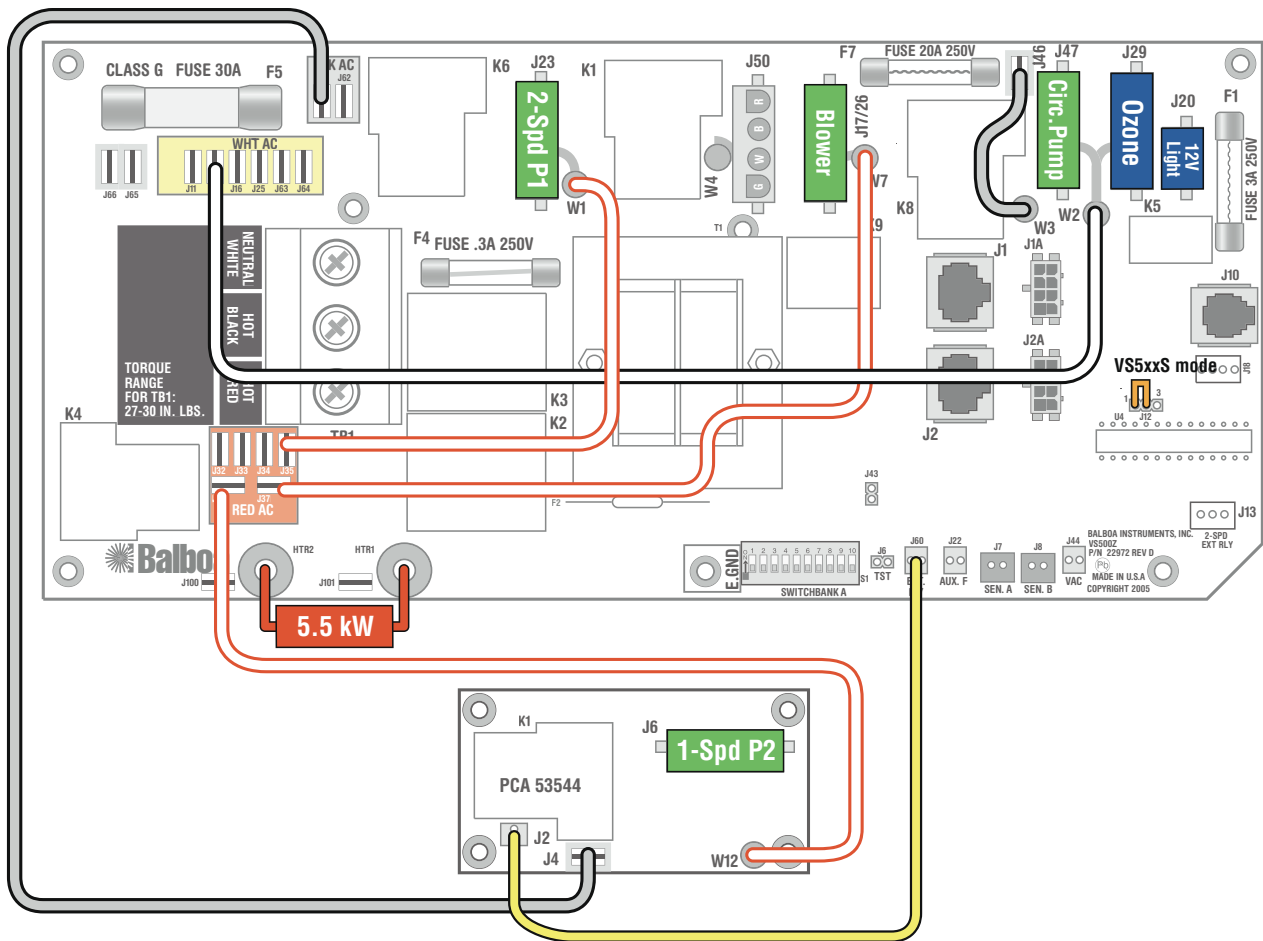

Wiring Color Key

- 120 Volt Connections
- 240 Volt Connections
- Black AC Jumpers
- 12 Volt Connections
- Relay Control Wires

PCB Revision	History
C	Production Release
D	Added Red AC connections J36 & J37; Added Aux Heater connections J100 & J101

Configuration Options

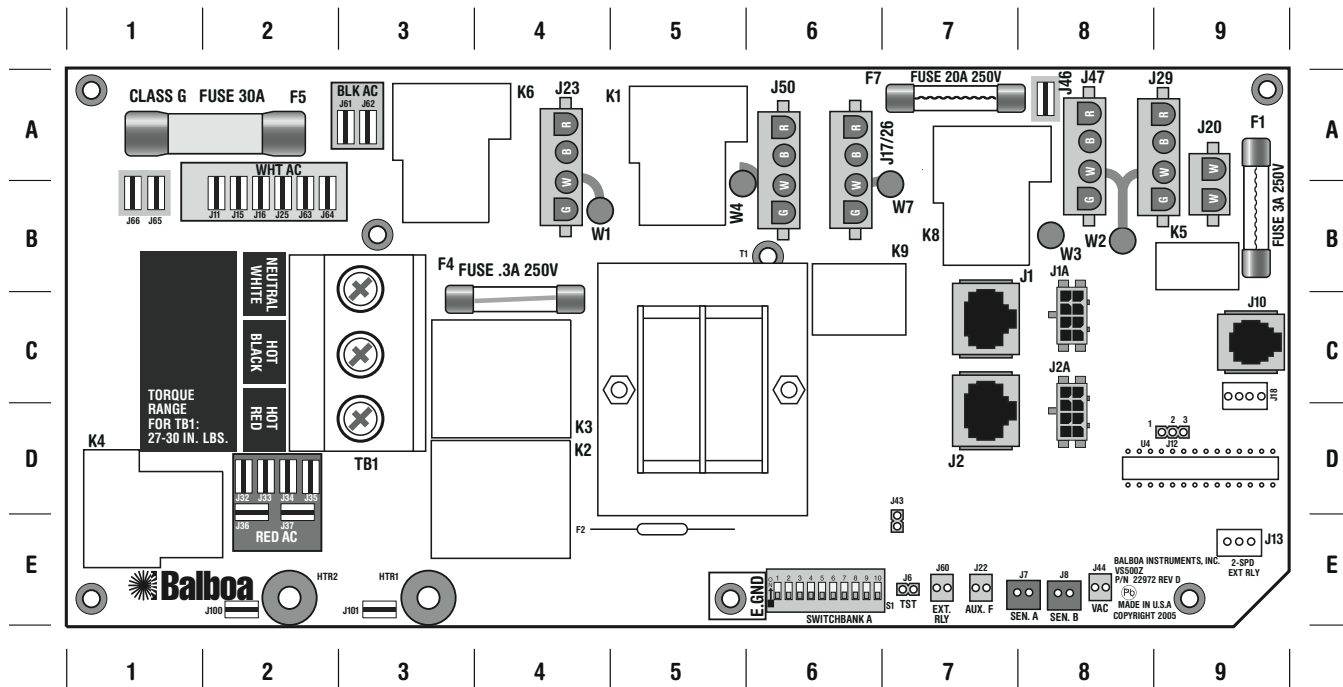

Output Features

Quadrant

J23	+ W1	- 2-Speed Pump 1	4-A
		- OR 1-Speed Pump 1 with DIP Switch A5	
J50	+ W4	- Audio Visual power output (Hot)	6-A
J17/26	+ W7	- 1-Speed Blower (W3 to J46)	6-B
		- OR Single-Speed Pump 2 or Pump 3 (W3 to J62)	
J47	+ W2	- Circ Pump	8-A
J29	+ W2	- Ozone (Same voltage as Circ Pump, if used)	9-A
		- Note X-03 option at right for retro fit	
J20		- Spa Light (12V only)	9-A

System can be factory configured for either a Duplex Topside Panel or a Serial Standard Panel.

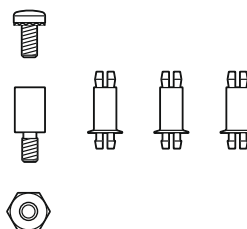

X-Mount P

PN 53933

Used for mounting any Expander Board in a plastic enclosure. Standoffs attach to heater mounting bracket.

Expander Options

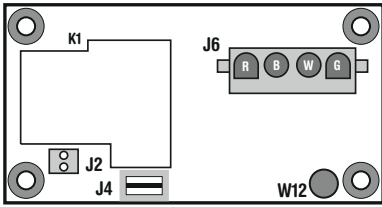

X-P **PN 53544**

Used for a 1-speed Pump output.
Represents a **VS510Z**.

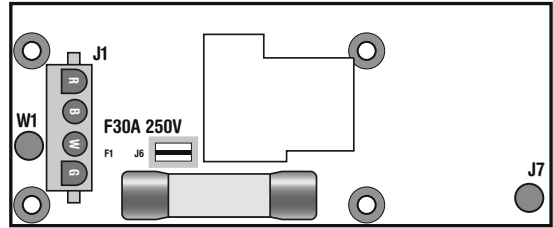

X-P231 **PN 53681**

Can replace the X-P in cases where branch circuit protection is needed for high amperage devices that would over-burden power input fuse F5 (1-A) on the main PCBA.

- J6 on the X-P231 connects directly to Black AC by using J66 or J65 on the main board (1-B).
- Connect J7 wire on the X-P231 to **J60** on the main board (7-E).
- Connect W1 on the X-P231 to Red AC on the main board (2-D).

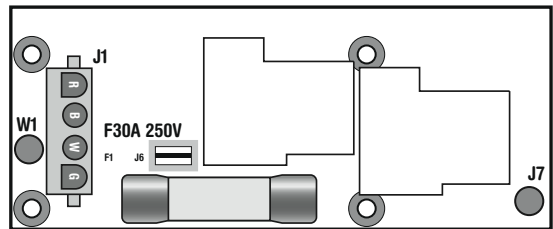

X-P332 **PN 53681**

Used for an additional 2-speed Pump output.
Represents a **VS521Z**.

- J6 on the X-P332 connects directly to Black AC by using J66 or J65 on the main board (1-B).
- Connect J7 wire on the X-P332 to **J13** on the main board (9-E).
- Connect W1 on the X-P332 to Red AC on the main board (2-D).

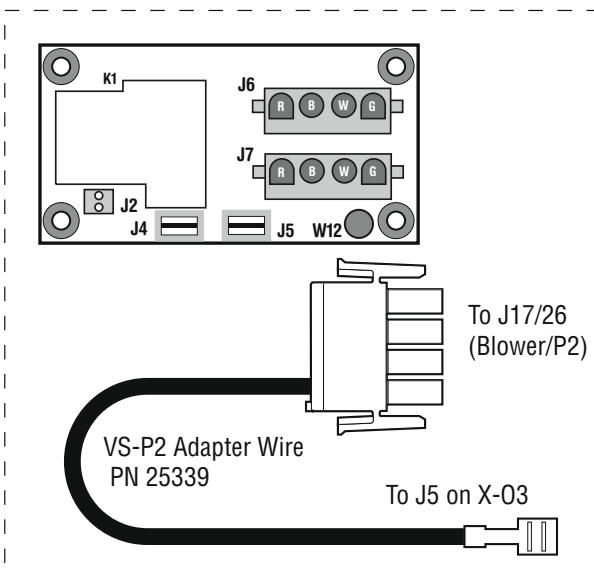

X-2SP Kit **PN 53913**

Adapter PN 25339 is used in conjunction with an X-03 to run a 2-speed pump 2.

- J4 connects to Black AC (3-A) using J61 or J62 on main board.
- Connect 2-speed pump to J7 on X-03.

No Blower is available when this kit is used.
Represents a **VS511Z**.

NOTE Regarding J12 (Quadrant 9-D):

When J12 on the Main Board is jumpered on pins 2 & 3, the system is in VS50xZ compatibility mode.

If J12 on the Main Board is jumpered on pins 1 & 2, the system is in VS51xZ/VS5xxSZ/VS5xxDZ compatibility mode.

DIP Switches and Jumpers

SSID #
100
65
23

Switchbank A

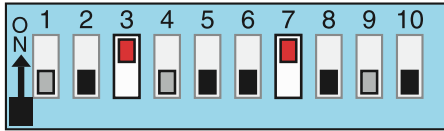

- | | |
|-----------------------------------|---------------------------|
| A1, Test Mode OFF | A6, 60 Hz |
| A2, Generic Panel layout | A7, J17/26 Enabled |
| A3, Off-board Pump enabled | A8, Degrees F |
| A4, Aux Freeze | A9, Circ Pump OFF |
| A5, 1-speed P1 w/Circ | A10, High Amp mode |

VS51x/VS5xxS/VS5xxD Compatible

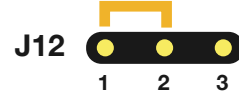

J43



Memory
Reset

DIP Switch Key

A1	Test Mode (normally Off)
A2	In "ON" position, Long Serial Standard panel (customer specific)
	In "OFF" position, Generic Balboa Serial Standard panel layout
A3	In "ON" position, off-board pump enabled
	In "OFF" position, off-board pump disabled
A4	Aux Freeze (must be OFF)
A5	In "ON" position, Two-speed pump 1
	In "OFF" position, One-speed pump 1 (A9 must be On and a circ pump installed)
A6	In "ON" position, 50Hz operation
	In "OFF" position, 60Hz operation
A7	In "ON" position, J17/26 equipment enabled
	In "OFF" position, J17/26 equipment disabled
A8	In "ON" position, temperature is displayed in degrees Celsius
	In "OFF" position, temperature is displayed in degrees Fahrenheit
A9	In "ON" Position, 24 Hour Circ Pump with 3°F shut off
	In "OFF" position, no circ pump
A10	In "ON" Position, heater is disabled while any high-speed pump or blower is running (low amperage mode)
	In "OFF" position, heater can run while any/all high-speed pumps or blowers are running (high amperage mode)

Jumper Key

- J12** Jumper on Pin 1 and 2 will enable VS51x/VS5xxS/VS5xxD compatibility mode.
Jumper on Pin 2 and 3 will enable VS50x compatibility mode (Do not use with Serial or Deluxe Panels).
- J43** When jumper is placed on 2 pins during power-up, system will reset persistent memory.
Leave on 1 pin only to enable persistent memory feature.

Ozone Connections

Ozone Connector Voltage: The VS500Z circuit board is factory configured to deliver a preset voltage (120V or 240V) to the on-board ozone connector (J29). See the ratings table on the wiring diagram attached to the cover of the enclosure for the configured voltage. For 240V output W2 connects to Red AC and for 120V output W2 connects to White AC.

The voltage to the ozone connector can be changed in the field if required. W2 just needs to be set for the required voltage.

WARNING: Changing the voltage of the ozone connector also effects the voltage supplied to the circ pump connector (J47). Any equipment controlled by that connector may be damaged if the wrong voltage is selected.

Balboa Ozone Generator: If the board is set up to operate a 120V ozone generator, the connector on the ozone generator is likely to be configured correctly, but should be compared to the illustration below.

If a 240V ozone generator is required, be sure the red wire in the ozone cord is positioned in the connector next to the green ground wire as described below.

Note: A special tool is required to remove the pins from the connector body once they are snapped in place. Check with your Balboa Account Manager for information on purchasing a pin-removal tool.

Balboa Ozone connector configuration for 120V 60Hz

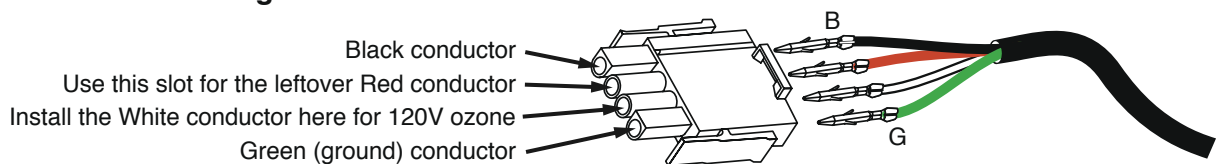

Balboa Ozone connector configuration for 240V 60Hz

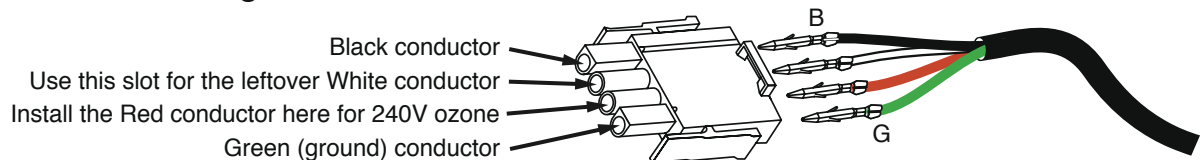

Serial Panel Configurations

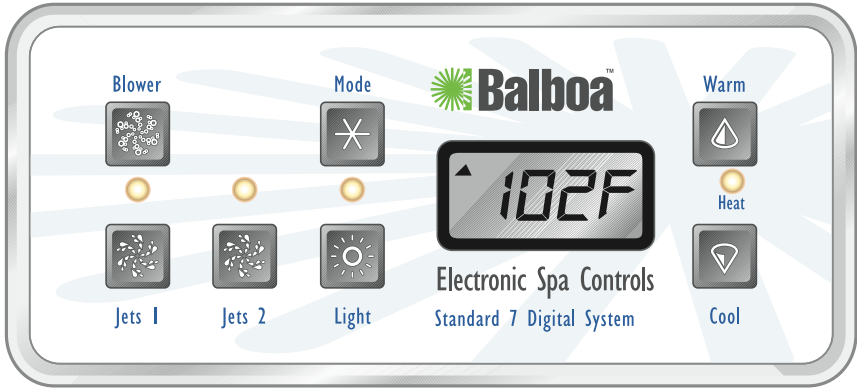

Serial Standard
PN 53189 with Overlay PN 10430
• Connects to Main Panel terminal J1