

# VS514SZ Tech Sheet

## Balboa Instruments System PN 54639-01

System Model # VSP-VS514SZ-YCAH

Software Version # 43

EPN # 2808

Base PCBA - PN 54638-01

PCB VS500Z - PN 22972 Rev C or D

Base Panels

VL701S (Serial Standard) – PN 55390



# System Revision History

System PN	EPN	Date	Requested By	Changes Made
54639-01	2808	08.27.2008	Balboa	Software update to version 43.

# Basic System Features and Functions

## Power Requirements

- 240VAC, 60Hz, 48A, Class A GFCI-protected service (Circuit Breaker rating = 60A max.)
- 4 wires (hot, hot, neutral, ground)

## System Outputs

### Setup 1 (As Manufactured)

- 240V Pump 1, 2-Speed
- 240V Pump 2, 1-Speed
- 240V Pump 3, 1-Speed
- 240V Ozone \*
- 12V Spa Light
- 120V AV (Stereo)
- 240V 5.5kW Heater \*\*

### Optional Devices

- 240V Circ Pump \*

\* Ozone and Circ Pump must be same voltage.

\*\* Heater wattage is rated at 240V. When running 120V to heater, output is approximately 25%.

## Additional Options

- Full Feature Dolphin Remote and Spa-only Dolphin Remote
- IR Receiver Module  
Connects to terminal J1 or J2
- MoodEFX Lighting  
Connects to Spa Light terminal J20
- FiberEFX Lighting  
Connects to Spa Light terminal J20

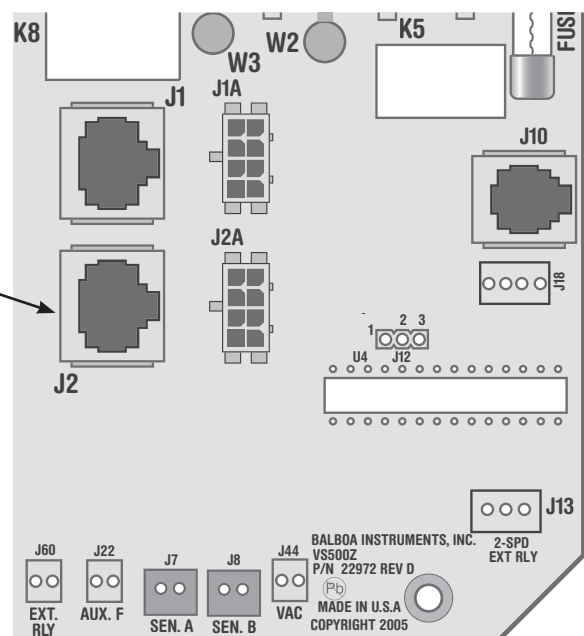

# Basic System Features and Functions

Any time you change a DIP Switch, other than A1, you must reset Persistent Memory for your new DIP Switch Settings changes to take effect. If you do not reset Persistent Memory, your system may function improperly.

## To reset Persistent Memory:

- Power down by disconnecting power source from spa.
- Put a jumper across J43, covering both pins. (See illustration below)
- Power up by connecting power source to spa.
- Wait until “P” is displayed on your panel.
- Power down again.
- Remove jumper from J43 (May also move to cover 1 pin only)
- Power up again.

## About Persistent Memory and Time of Day Retention:

This system uses memory that doesn't require a battery to store a variety of settings. What we refer to as Persistent Memory stores the filter settings, the set temperature, and the heat mode.

Persistent Memory is not used for Time of Day. Only models with a Serial Deluxe panel installed (VS5xxDZ and GS5xxDZ) can display the time. However, during power loss to the spa, the system will lose the correct time, and reset to 12:00 PM when power is restored.

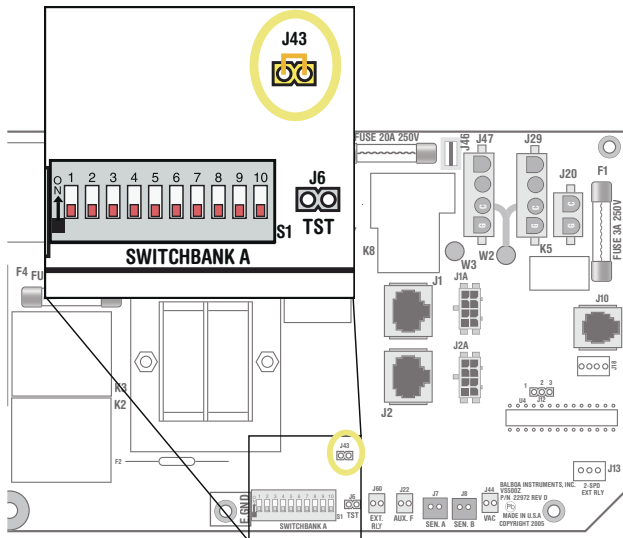

J43 on VS5xxZ and VS300 Series Main Board Shown.

## Power Up Display Sequence

Upon power up, you should see the following on the display:

- Three numbers in a row, which are the SSID (the System Software ID). The third display of these numbers is the Software Version, which should match the version of your system. For example, if these three numbers are 100 67 38, that is a VS511SZ at version 38.
- Displayed next is: “24” (indicating the system is configured for a heater between 3 and 6 kW) or “12” (indicating the system is configured for a heater effectively\* between 1 and 3 kW). “24” should appear for all VS models running at 240VAC. “12” should appear for all VS models running at 120VAC, as well as all GS models. (\*A heater which is rated at 4 kW at 240VAC will function as a 1 kW heater at 120VAC.)
- “P” will appear to signal the start of Priming Mode.

At this point, the power up sequence is complete. Refer to the Reference Card for the VS or GS System model of your spa for information about how the spa operates from this point on, including how to adjust the Time of Day if using a Serial Deluxe style panel.

# Wiring Configuration and DIP Settings

## Setup 1 (As Manufactured)

- 240V Pump 1, 2-Speed
- 240V Pump 2, 1-Speed
- 240V Pump 3, 1-Speed
- 12V Spa Light
- 240V Ozone
- 120V AV (Stereo)
- 240V 5.5kW Heater
- VL701S Main Panel

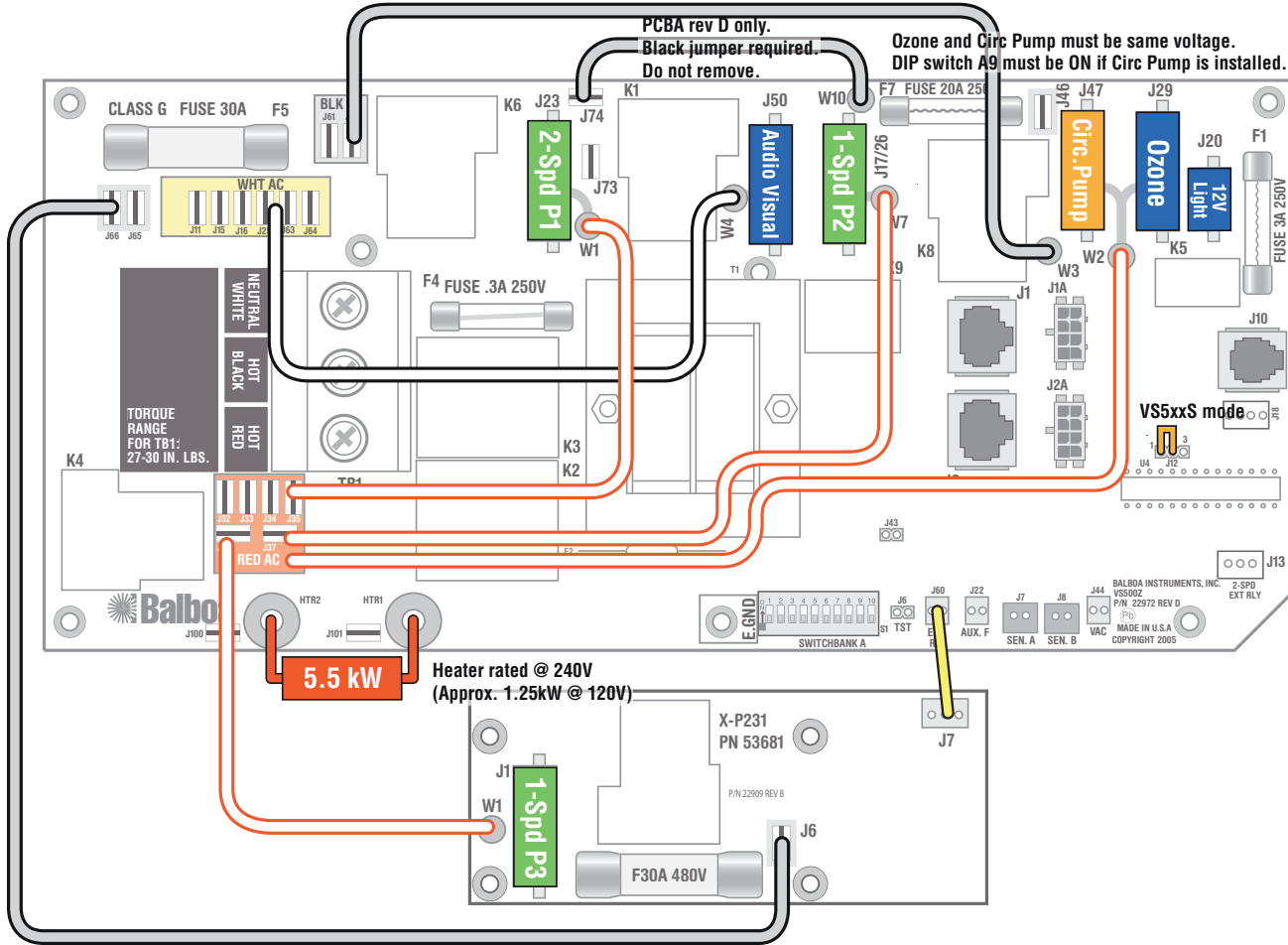

**WARNING:** Main Power to system should be turned OFF BEFORE adjusting DIP switches.  
**WARNING:** Persistent Memory (J43) must be RESET to allow new DIP switch settings to take effect. (See Persistent Memory page)

**SSID #**

100  
93  
43

**Switchbank A**

A1, Test Mode OFF      A6, 60 Hz  
 A2, See Table 1      A7, Exp Board Equip Enabled  
 A3, J17/26 Pump Enabled      A8, Degrees F  
 A4, Aux Freeze      A9, Non-Circ Mode  
 A5, 2-speed P1      A10, See Table 1

**Wiring Color Key**

- 120 Volt Connections
- 240 Volt Connections
- Black AC Jumpers
- 12 Volt Connections
- Relay Control Wires

**Panel Button Assignments**

1=Mode      5=Pump 1  
 2=Temp Up      6=Pump 2  
 3=Temp Down      7=Unused d  
 4=Light

**Panel Button Positions**

**Board Connector Key**

1 Typically Line voltage  
 2 Typically Line voltage for 2-speed pumps  
 3 Neutral (Common)  
 4 Ground

Note flat sides in connector

VS51x/VS5xxS/VS5xxD Compatible

J12

J43 Memory Reset

# DIP Switches and Jumpers Definitions

## SSID 100 93 43

## Base Model VS503SZ-VS504SZ-VS514SZ

### DIP Switch Key

- A1 Test Mode (normally OFF)
- A2+A10 Control amp draw requirements (See Table 1)
- A3 "ON" position: J17/26 Enabled for 1-speed Pump only.  
"OFF" position: J17/26 Disabled.
- A4 Aux Freeze (must be OFF)
- A5+A9 Pump 1 speeds and Circ Modes:

A5	A9	Circ Mode	Pump 1 Speed
OFF	OFF	Non-circ	2-speed
ON	OFF	Circ "acts like Pump 1 low" (filters/polls/ect)	1-speed
OFF	ON	24 hours with 3°F shut-off	1-speed
ON	ON	24 hours with 3°F shut-off	2-speed

- A6 "ON" position: 50Hz operation  
"OFF" position: 60Hz operation
- A7 "ON" position: Expander Board Enabled for Blower or 1-speed Pump.  
"OFF" position: Expander Board Disabled
- A8 "ON" position: temperature is displayed in degrees Celsius  
"OFF" position: temperature is displayed in degrees Fahrenheit

When using a Blower, use X-B expander board. When using a 1-speed Pump 3, use X-P or X-P231, depending on amperage requirements.

\* Panel with button layout  is not compatible.

**Table 1**

		# of Hi-Speed Pumps/Blower Before Heat Disabled
A2	A10	
OFF	OFF	0
ON	OFF	1
OFF	ON	2
ON	ON	3

### Jumper Key

#### J12 Factory set. DO NOT MOVE.

Jumper must be on Pins 1 and 2 for VS51xZ/VS52xZ/VS5xxSZ/VS5xxDZ software.

Jumper must be on Pins 2 and 3 for VS50xZ software.

#### J43 When jumper is placed on 2 pins during power-up, system will reset persistent memory.

Leave on 1 pin only to enable persistent memory feature.

### WARNING:

- Setting DIP switches incorrectly may cause abnormal system behavior and/or damage to system components.
- Refer to Switchbank illustration on Wiring Configuration page for correct settings for this system.
- Contact Balboa if you require additional configuration pages added to this tech sheet.

### Panel Button Positions

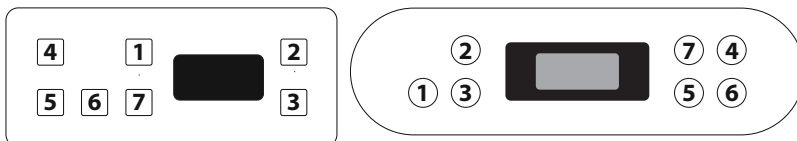

### Panel Button Assignments

- 1=Mode
- 2=Temp Up
- 3=Temp Down
- 4=Light
- 5=Pump 1
- 6=Pump 2 (when A3 is ON)
- 7=Exp Board (when A7 is ON)

### Aux Panel Information

Supports 2-button aux panel



Supports 4-button aux panel



# Expander Options

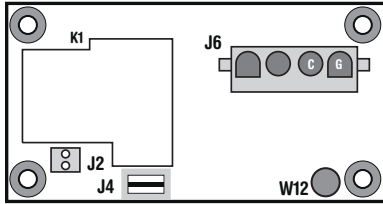

**X-P PN 53544**

Used for a 1-speed Pump output.

- J4 on X-P connects directly to Black AC using J62 or J61 on the main VS500Z PCBA.
- J2 on X-P connects to J60 on the main board.
- W12 on X-P connects directly to Red AC (240V) or White AC (120V) on the main VS500Z PCBA.

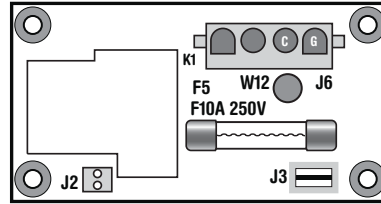

**X-B PN 53310**

Used for a Blower output ONLY.

- J3 on X-B connects directly to Black AC using J62 or J61 on the main VS500Z PCBA.
- J2 on X-B connects to J60 on the main board.
- W12 on X-B connects directly to Red AC (240V) or White AC (120V) on the main VS500Z PCBA.

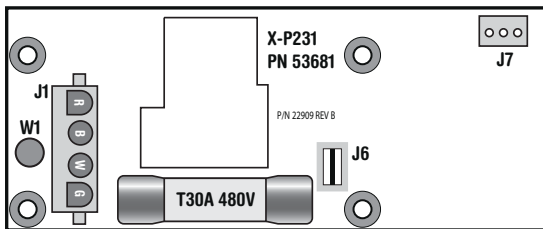

**X-P231 PN 53681**

Can replace the X-P in cases where branch circuit protection is needed for high amperage devices that would over-burden power input fuse F5 (1-A) on the main PCBA.

- J6 on the X-P231 connects directly to Black AC by using J66 or J65 on the main board (1-B).
- Connect J7 wire on the X-P231 to **J60** on the main board (7-E).
- Connect W1 on the X-P231 to Red AC (240V) or White AC (120V) on the main board.

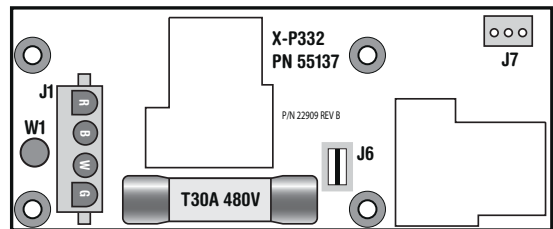

**X-P332 PN 55137**

Used for an additional 2-speed Pump output.

- J6 on the X-P332 connects directly to Black AC by using J66 or J65 on the main board (1-B).
- Connect J7 wire on the X-P332 to **J13** on the main board (9-E).
- Connect W1 on the X-P332 to Red AC (240V) or White AC (120V) on the main board.

Can also be used with a PS-23 cable (PN 25089) on model VS523DZ to control two 1-speed Pumps.

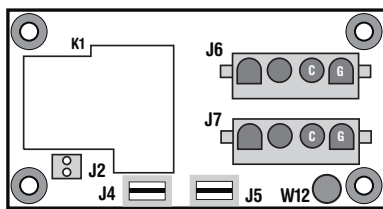

**X-2SP Kit PN 53913**

Adapter PN 25339 is used in conjunction with an X-03 to run a 2-speed pump 2. No Blower is available when this kit is used.

- J4 connects to Black AC (3-A) using J61 or J62 on main board.
- Connect 2-speed pump to J7 on X-03.
- J2 on X-03 connects to J60 on the main board.
- W12 on X-03 connects directly to Red AC (240V) or White AC (120V) on the main VS500Z PCBA.

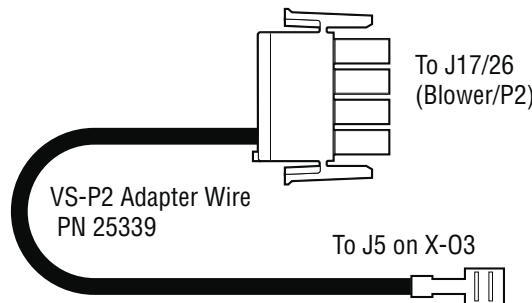

# Ozone Connections

**Ozone Connector Voltage:** The VS500Z circuit board is factory configured to deliver a preset voltage (120V or 240V) to the on-board ozone connector (J29). See the ratings table on the wiring diagram attached to the cover of the enclosure for the configured voltage. For 240V output W2 connects to Red AC and for 120V output W2 connects to White AC.

The voltage to the ozone connector can be changed in the field if required. W2 just needs to be set for the required voltage.

**WARNING: Changing the voltage of the ozone connector also effects the voltage supplied to the circ pump connector (J47).** Any equipment controlled by that connector may be damaged if the wrong voltage is selected.

**Balboa Ozone Generator:** If the board is set up to operate a 120V ozone generator, the connector on the ozone generator is likely to be configured correctly, but should be compared to the illustration below.

If a 240V ozone generator is required, be sure the red wire in the ozone cord is positioned in the connector next to the green ground wire as described below.

*Note: A special tool is required to remove the pins from the connector body once they are snapped in place. Check with your Balboa Account Manager for information on purchasing a pin-removal tool.*

## Balboa Ozone connector configuration for 120V 60Hz

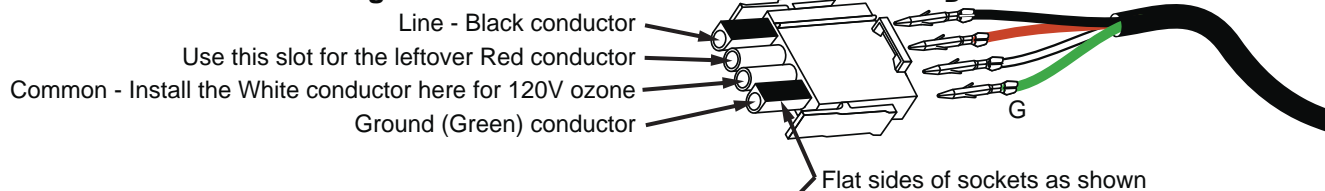

## Balboa Ozone connector configuration for 240V 60Hz

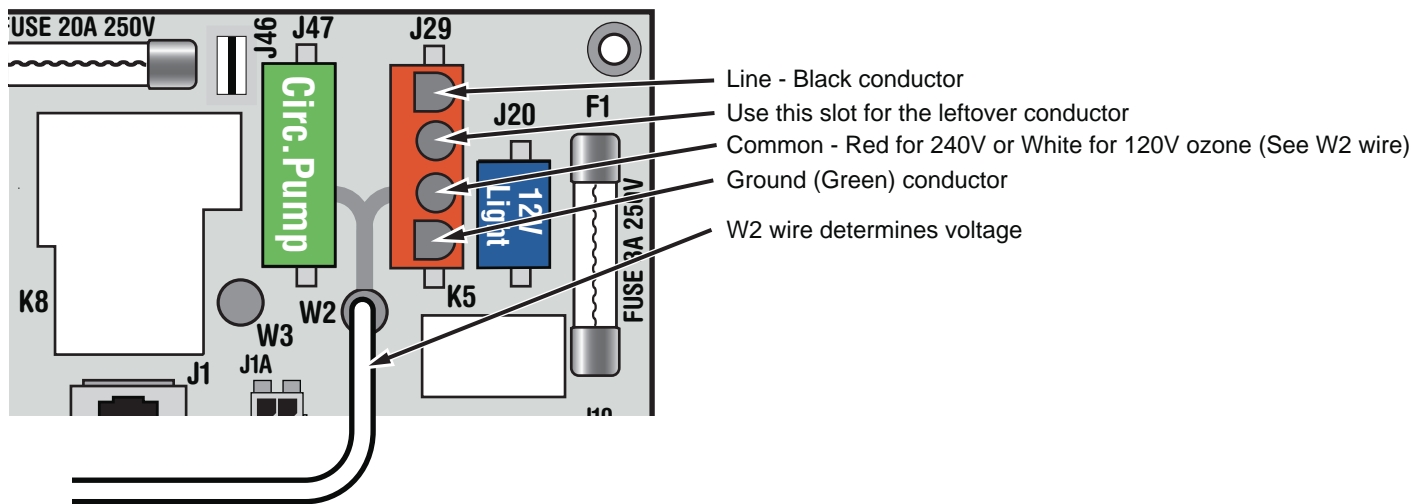
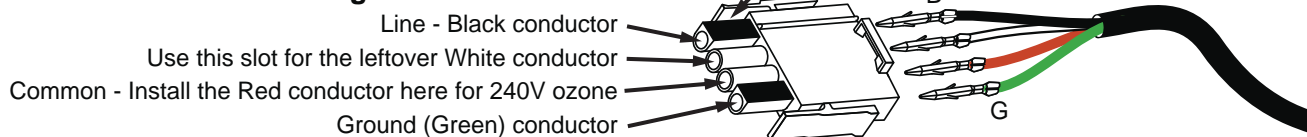



# Serial Standard Panel Configurations

## SETUP 1

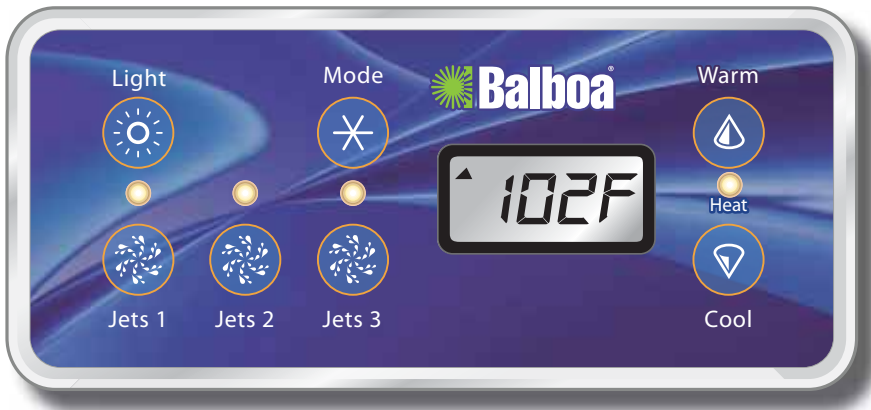

VL701S (Serial Standard)  
PN 55390 with Overlay PN 11984  
• Connects to Main Panel terminal J1