

VS520DZ 4.0kW Tech Sheet

Balboa System PN 55663

System Model # VSP-VS520DZ-BCAJ

Software Version # 43

EPN # 3136

Base PCBA - PN 55152-01

PCB VS500Z - PN 22972 Rev E

Base Panels

VL801D (Serial Deluxe) – PN 54108

VL802D – PN 54528



System Revision History

System PN	EPN	Date	Requested By	Changes Made
55663	3136	02.17.2009	Balboa	New System.

Basic System Features and Functions

Power Requirements

- 240VAC, 60Hz, 48A, Class A GFCI-protected service (Circuit Breaker rating = 60A max.)
- 4 wires [hot, hot, neutral, ground]

System Outputs

Setup 1 (As Manufactured)

- 240V Pump 1, 2-Speed
- 240V Pump 2, 2-Speed
- 240V Blower
- 120V Ozone
- 12V Spa Light
- 120V AV (Stereo)
- 240V 4.0kW Heater *

* Heater wattage is rated at 240V. When running 120V to heater, output is approximately 25%.

Additional Options

- Full Feature Dolphin Remote and Spa-only Dolphin Remote
Connects to terminal J1 or J2
- IR Receiver Module
Connects to Spa Light terminal J20
- MoodEFX Lighting
Connects to Spa Light terminal J20
- FiberEFX Lighting
Connects to Spa Light terminal J20

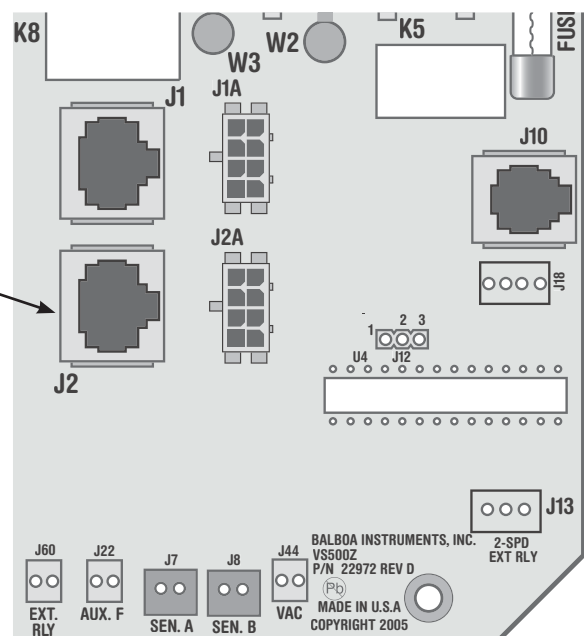

Basic System Features and Functions

Power Requirements

- 240VAC, 60Hz, 48A, Class A GFCI-protected service (Circuit Breaker rating = 60A max.)
- 4 wires [hot, hot, neutral, ground]

System Outputs

Setup 2

- 240V Pump 1, 2-Speed
- 240V Pump 2, 2-Speed
- 240V Blower
- 120V Ozone *
- 120V Circ Pump *
- 12V Spa Light
- 120V AV (Stereo)
- 240V 4.0kW Heater **

* Ozone and Circ Pump must be same voltage.

** Heater wattage is rated at 240V. When running 120V to heater, output is approximately 25%.

Additional Options

- Full Feature Dolphin Remote and Spa-only Dolphin Remote
- IR Receiver Module
Connects to terminal J1 or J2
- MoodEFX Lighting
Connects to Spa Light terminal J20
- FiberEFX Lighting
Connects to Spa Light terminal J20

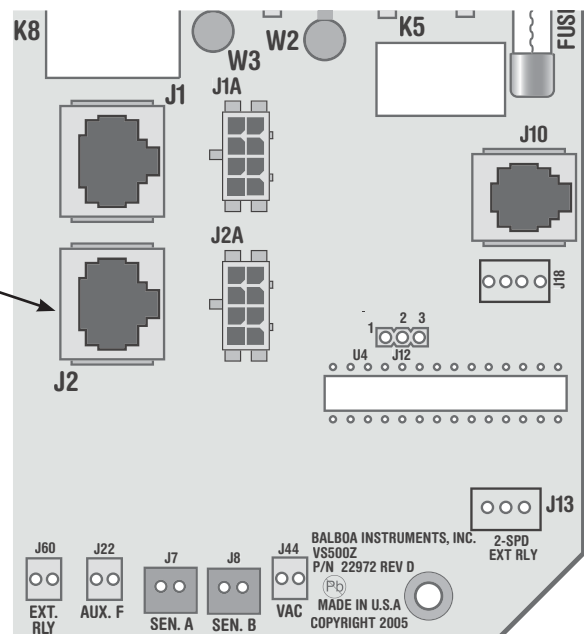

Basic System Features and Functions

Any time you change a DIP Switch, other than A1, you must reset Persistent Memory for your new DIP Switch Settings changes to take effect. If you do not reset Persistent Memory, your system may function improperly.

To reset Persistent Memory:

- Power down by disconnecting power source from spa.
- Put a jumper across J43, covering both pins. (See illustration below)
- Power up by connecting power source to spa.
- Wait until “P” is displayed on your panel.
- Power down again.
- Remove jumper from J43 (May also move to cover 1 pin only)
- Power up again.

About Persistent Memory and Time of Day Retention:

This system uses memory that doesn't require a battery to store a variety of settings. What we refer to as Persistent Memory stores the filter settings, the set temperature, and the heat mode.

Persistent Memory is not used for Time of Day. Only models with a Serial Deluxe panel installed (VS5xxDZ and GS5xxDZ) can display the time. However, during power loss to the spa, the system will lose the correct time, and reset to 12:00 PM when power is restored.

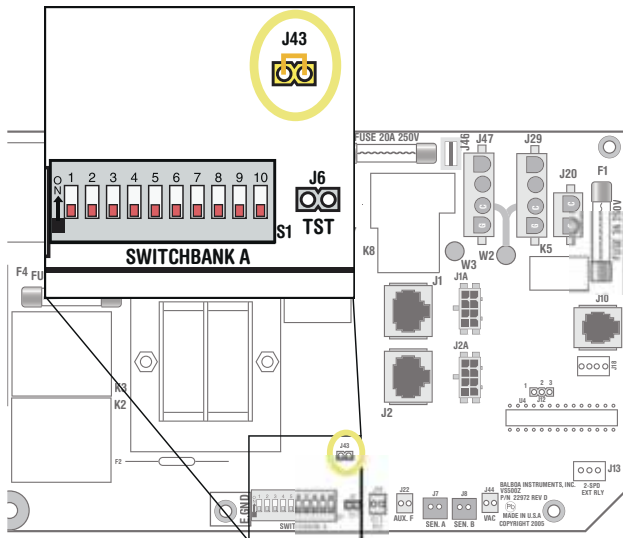

J43 on VS5xxZ and VS300 Series Main Board Shown.

Power Up Display Sequence

Upon power up, you should see the following on the display:

- Three numbers in a row, which are the SSID (the System Software ID). The third display of these numbers is the Software Version, which should match the version of your system. For example, if these three numbers are 100 67 38, that is a VS511SZ at version 38.
- Displayed next is: “24” (indicating the system is configured for a heater between 3 and 6 kW) or “12” (indicating the system is configured for a heater effectively* between 1 and 3 kW). “24” should appear for all VS models running at 240VAC. “12” should appear for all VS models running at 120VAC, as well as all GS models. (*A heater which is rated at 4 kW at 240VAC will function as a 1 kW heater at 120VAC.)
- “P” will appear to signal the start of Priming Mode.

At this point, the power up sequence is complete. Refer to the Reference Card for the VS or GS System model of your spa for information about how the spa operates from this point on, including how to adjust the Time of Day if using a Serial Deluxe style panel.

Wiring Configuration and DIP Settings

Setup 1 (As Manufactured)

- 240V Pump 1, 2-Speed
- 240V Pump 2, 2-Speed
- 240V Blower
- 120V Ozone
- 12V Spa Light
- 120V AV (Stereo)
- 240V 4.0kW Heater
- VL801D Main Panel

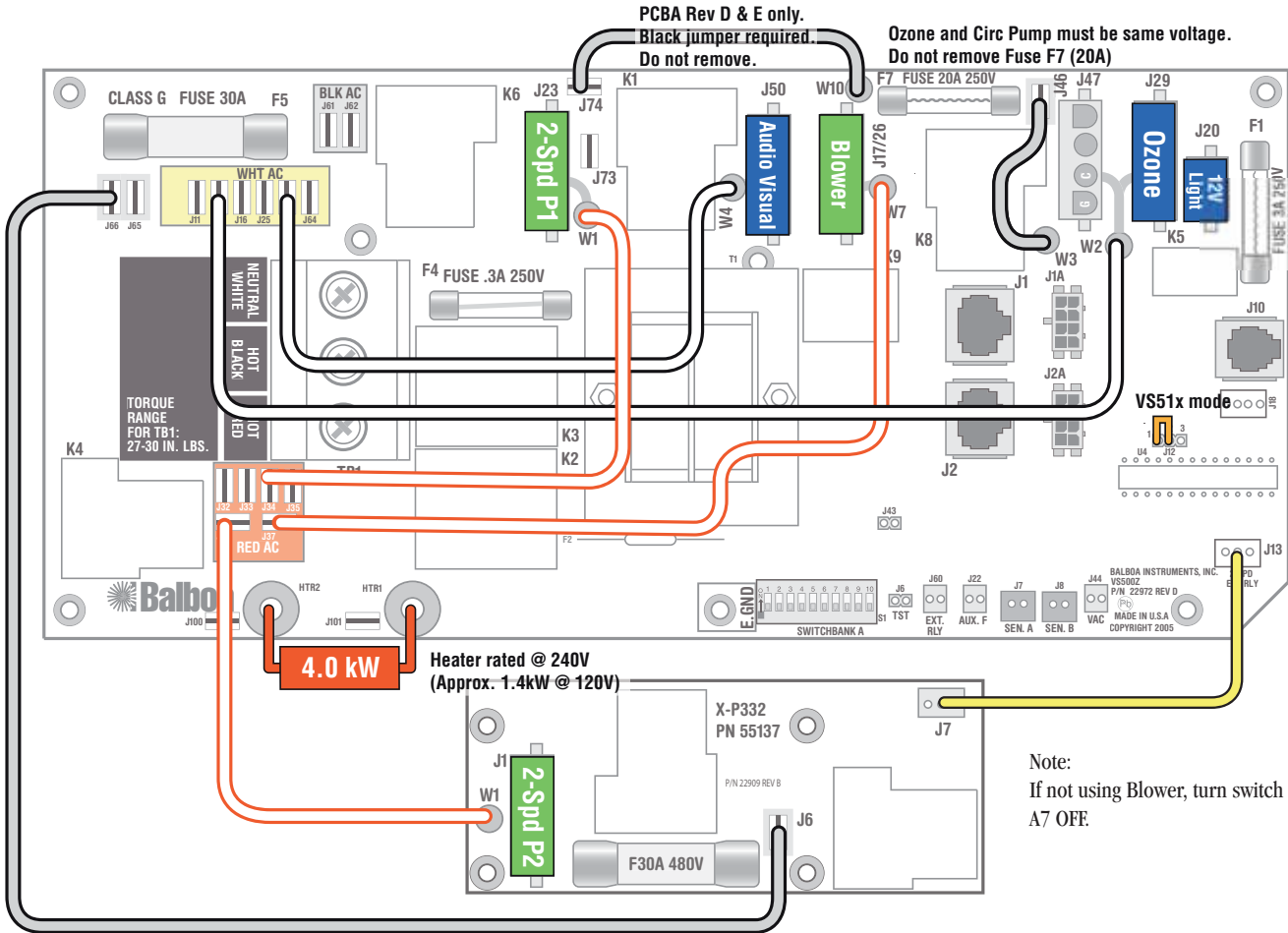

WARNING: Main Power to system should be turned OFF BEFORE adjusting DIP switches.
WARNING: Persistent Memory (J43) must be RESET to allow new DIP switch settings to take effect. (See Persistent Memory page)

SSID #
 100
 94
 43

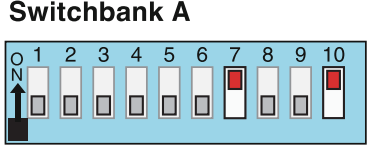

- | | |
|-------------------|--------------------|
| A1, Test Mode OFF | A6, 60 Hz |
| A2, See Table 1 | A7, J17/26 Enabled |
| A3, N/A | A8, Degrees F |
| A4, Aux Freeze | A9, Non-Circ Mode |
| A5, 2-speed P1 | A10, See Table 1 |

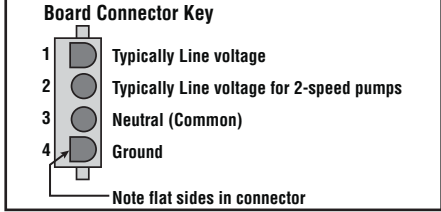
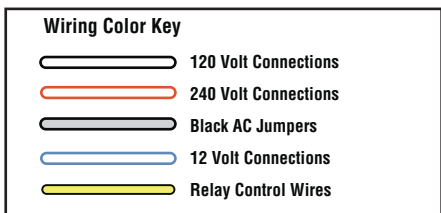
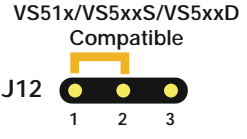

- Panel Button Assignments
- | | |
|-------------|----------|
| 1=Time | 5=Light |
| 2=Mode/Prog | 6=Pump 1 |
| 3=Temp Up | 7=Pump 2 |
| 4=Temp Down | 8=J17/26 |

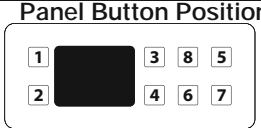

Wiring Configuration and DIP Settings

Setup 2

- 240V Pump 1, 2-Speed
- 240V Pump 2, 2-Speed
- 240V Blower
- 120V Ozone
- 120V Circ Pump
- 12V Spa Light
- 120V AV (Stereo)
- 240V 4.0kW Heater
- VL802D Main Panel

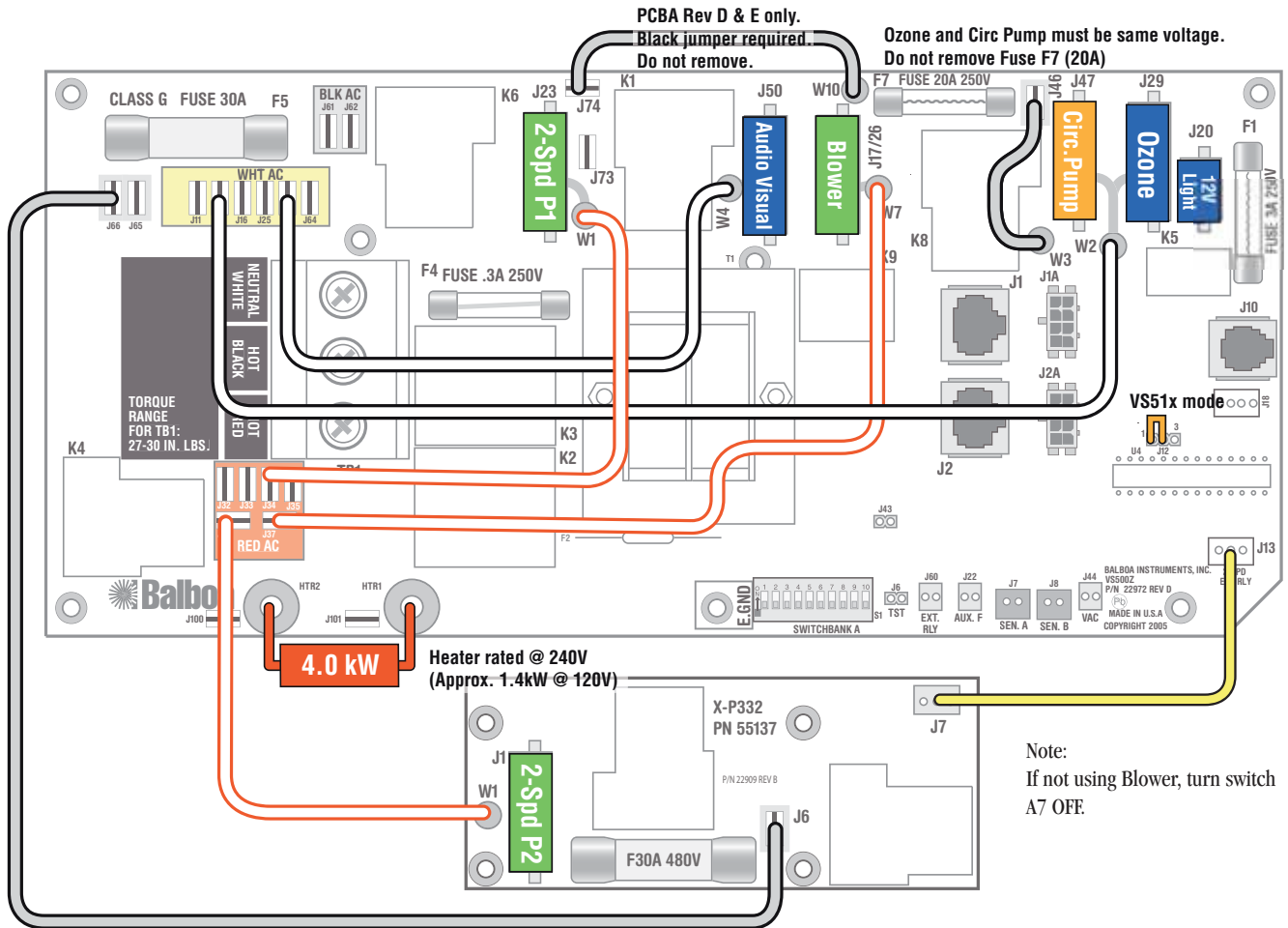

WARNING: Main Power to system should be turned OFF BEFORE adjusting DIP switches.
WARNING: Persistent Memory (J43) must be RESET to allow new DIP switch settings to take effect. (See Persistent Memory page)

SSID #

100
94
43

Switchbank A

A1, Test Mode OFF	A6, 60 Hz
A2, See Table 1	A7, J17/26 Enabled
A3, N/A	A8, Degrees F
A4, Aux Freeze	A9, 24 Hour 3°F Circ Pump
A5, 2-speed P1	A10, See Table 1

VS51x/VS5xxS/VS5xxD Compatible

J12

Wiring Color Key

- 120 Volt Connections
- 240 Volt Connections
- Black AC Jumpers
- 12 Volt Connections
- Relay Control Wires

Board Connector Key

- 1 Typically Line voltage
- 2 Typically Line voltage for 2-speed pumps
- 3 Neutral (Common)
- 4 Ground

Note flat sides in connector

Panel Button Assignments

1=Time	5=Light
2=Mode/Prog	6=Pump 1
3=Temp Up	7=Pump 2
4=Temp Down	8=J17/26

Panel Button Positions

DIP Switches and Jumpers Definitions

SSID 100 94 43

Base Model VS520DZ

DIP Switch Key

- A1 Test Mode (normally OFF)
- A2+A10 Control amp draw requirements (See Table 1)
- A3 N/A (must be OFF)
- A4 Aux Freeze (must be OFF)
- A5+A9 Pump 1 speeds and Circ Modes:

A5	A9	Circ Mode	Pump 1 Speed
OFF	OFF	Non-circ	2-speed
ON	OFF	Circ "acts like Pump 1 low" (filters/polls/ect)	1-speed
OFF	ON	24 hours with 3°F shut-off	1-speed
ON	ON	24 hours with 3°F shut-off	2-speed

- A6 "ON" position: 50Hz operation
"OFF" position: 60Hz operation
- A7 "ON" position: J17/26 Enabled for Blower or 1-speed Pump 3.
"OFF" position: J17/26 Disabled.
- A8 "ON" position: temperature is displayed in degrees Celsius
"OFF" position: temperature is displayed in degrees Fahrenheit

Table 1

of Hi-Speed
Pumps/Blower
Before Heat Disabled

A2	A10	
OFF	OFF	0
ON	OFF	1
OFF	ON	2
ON	ON	3

Alert:

2-speed Pump 2 is required, uses X-P332 expander board.
To add Blower or 1-speed Pump 3, use J17/26.

Jumper Key

J12 **Factory set. DO NOT MOVE.**

Jumper must be on Pins 1 and 2 for VS51xZ/VS52xZ/VS5xxSZ/VS5xxDZ software.

Jumper must be on Pins 2 and 3 for VS50xZ software.

J43 When jumper is placed on 2 pins during power-up, system will reset persistent memory.

Leave on 1 pin only to enable persistent memory feature.

WARNING:

- Setting DIP switches incorrectly may cause abnormal system behavior and/or damage to system components.
- Refer to Switchbank illustration on Wiring Configuration page for correct settings for this system.
- Contact Balboa if you require additional configuration pages added to this tech sheet.

Panel Button Positions

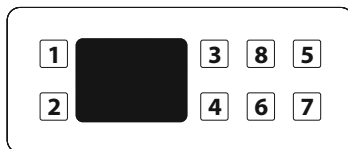

Panel Button Assignments

- 1=Time
- 2=Mode/Prog
- 3=Temp Up
- 4=Temp Down
- 5=Light
- 6=Pump 1
- 7=Pump 2
- 8=J17/26 (when A7 is ON)

Aux Panel Information

Supports 2-button aux panel



Supports 4-button aux panel



Ozone Connections

Ozone Connector Voltage: The VS500Z circuit board is factory configured to deliver a preset voltage (120V or 240V) to the on-board ozone connector (J29). See the ratings table on the wiring diagram attached to the cover of the enclosure for the configured voltage. For 240V output W2 connects to Red AC and for 120V output W2 connects to White AC.

The voltage to the ozone connector can be changed in the field if required. W2 just needs to be set for the required voltage.

WARNING: Changing the voltage of the ozone connector also effects the voltage supplied to the circ pump connector (J47). Any equipment controlled by that connector may be damaged if the wrong voltage is selected.

Balboa Ozone Generator: If the board is set up to operate a 120V ozone generator, the connector on the ozone generator is likely to be configured correctly, but should be compared to the illustration below.

If a 240V ozone generator is required, be sure the red wire in the ozone cord is positioned in the connector next to the green ground wire as described below.

Note: A special tool is required to remove the pins from the connector body once they are snapped in place. Check with your Balboa Account Manager for information on purchasing a pin-removal tool.

Balboa Ozone connector configuration for 120V 60Hz

- Line - Black conductor
- Use this slot for the leftover Red conductor
- Common - Install the White conductor here for 120V ozone
- Ground (Green) conductor

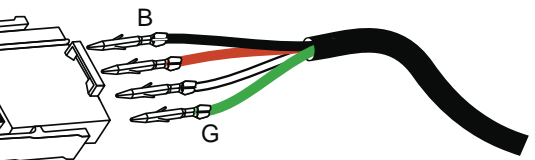

Flat sides of sockets as shown

Balboa Ozone connector configuration for 240V 60Hz

- Line - Black conductor
- Use this slot for the leftover White conductor
- Common - Install the Red conductor here for 240V ozone
- Ground (Green) conductor

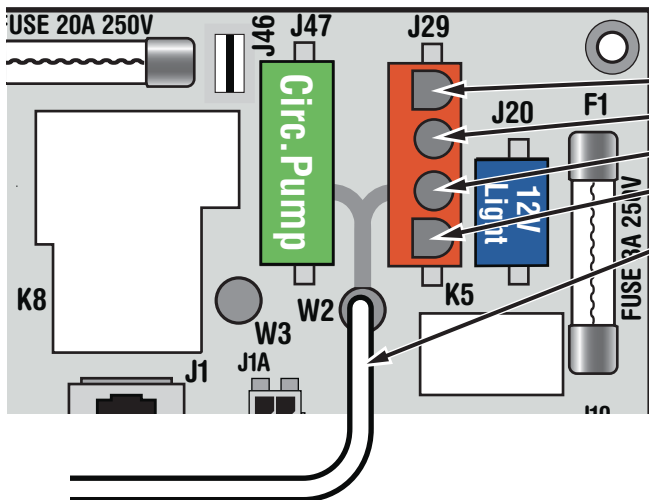
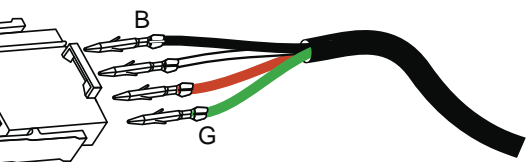

- Line - Black conductor
- Use this slot for the leftover conductor
- Common - Red for 240V or White for 120V ozone (See W2 wire)
- Ground (Green) conductor
- W2 wire determines voltage

Serial Deluxe Panel Configurations

SETUP 1



VL801D (Serial Deluxe)

PN 54108 with Overlay PN 10763

- Connects to Main Board terminal J1 only*



VL802D

PN 54528 with Overlay PN 11789

- Connects to Main Board terminal J1 only*

* Panels with back-lighting (bulbs installed) should never be plugged into J2. Use J1 only. If the backlight bulbs are removed, then both J1 and J2 may be used.