

# EL1000P2 Mach 3 Hot Sheet

## Balboa Instruments System PN 54396-02

System Model # E1P-EL1000P2-DCAH  
Software Version # 28  
EPN # 2130

Base PCBA - PN 54397-02  
PCB EL1000 – PN 22952 Rev B or C

Base Panels  
ML400 – PN 52684



# Basic System Features and Functions

## Power Requirements

- 240VAC, 60Hz, 40A, Class A GFCI-protected service (Circuit Breaker rating = 50A max.)
- 4 wires (hot, hot, neutral, ground)

## System Outputs

### Setup 1 (As Manufactured)

- 240V Pump 1, 2-Speed
- 240V Pump 2, 1-Speed
- 240V Circ Pump
- 120V Ozone
- 12V Spa Light
- 240V 5.5kW Heater

## Additional Options

- Full Feature Dolphin Remote and Spa-only Dolphin Remote
- Spa Monitor  
Connects to Main Panel terminal J70 or J71
- IR or RF Dolphin Receiver Module  
Connects to Remote terminal J20
- Ozone Generator  
Connects to terminal J9
- MoodEFX Lighting  
Connects to Spa Light terminal J12
- FiberEFX Lighting  
Connects to Spa Light terminal J12
- Stereo System  
Connects to A.V. terminal J2

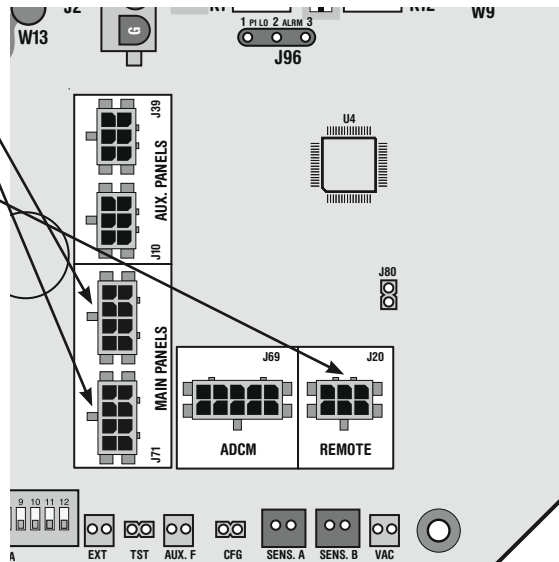

# Persistent Memory and Powering Up

Any time you change DIP Switches or Software Configuration Settings that affect parameters the user can change (any filter settings, set temperature default, Celsius vs Fahrenheit, 12-hour vs 24-hour time, reminders suppression, etc), you must reset Persistent Memory for your DIP Switch or Software Configuration Settings changes to take effect. You should also reset Persistent Memory after loading a new file into a board (using the ESM, purchased separately).

## To reset Persistent Memory:

- Power down.
- Set A12 ON (See illustration below).
- Power up.
- Wait until “P” or “PRIMING MODE” is displayed on your panel. Note: If “CFE” appears see section below.
- Set A12 OFF. (This can be done safely with power on if you use a non-conductive tool such as a pencil to push the switch back to the OFF position. Otherwise, power down before setting A12 OFF)
- Power up again (if you powered down in the previous step).
- For all other power ups, leave A12 OFF.

## About Persistent Memory and Time of Day Retention:

This system uses memory that doesn't require a battery to store a variety of settings. What we refer to as Persistent Memory stores all the User Preferences, as well as all the filter settings, the set temperature, and the heat mode.

Persistent Memory is not used for Time of Day. Time of Day needs to be “kept running” (not just stored) while the power is off, so a separate Real Time Clock feature (on all models except the EL1000) keeps track of Time of Day while the unit is off. Time of Day Retention, and Time of Day Retention alone, is controlled by the J91 jumper. J91 must be set according to main system panel used.

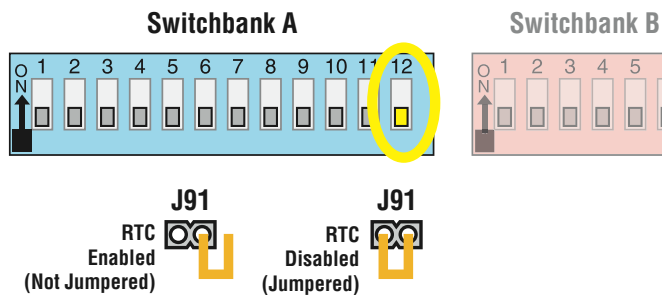

## CFE message on power up:

If “CFE” appears before (and instead of) “P” or “PRIMING MODE”, you have not configured DIP Switches and/or Software Configuration Settings in a valid manner. This must be corrected before you can reset Persistent Memory.

The switch numbers, jumpers, or configuration settings displayed after “CFE” are ones with which the system has found a configuration problem. For example:

- “CFE A5 B2” would mean that the combination of how you've set A5 and how you've set B2 is not supported on this system.
- “CFE J99” would mean that there is a problem with jumper J99
- “CFE P3 1 BL 1” would mean that the combination of how you've set pump 3 for 1-speed and blower for 1-speed is not supported on this system.
- “CFE P3 BL” would mean that the combination of how you've set DIP switches which have been assigned to pump 3 and blower is not supported on this system.

## Power Up Display Sequence

Upon power up, you should see the following on the display:

- Three numbers in a row, which are the SSID (the System Software ID). The third display of these numbers is the Software Version, which should match the version of your system. For example, if these three numbers are 100 134 26, that is a Mach 3 EL8000 at version 26.
- If there is a Configuration Error, the CFE message (see above) will appear at this point (and none of the messages below will display). Otherwise what comes next is:
- “3-6” (indicating the system is configured for a heater between 3 and 6 kW) or “1-3” (indicating the system is configured for a heater effectively\* between 1 and 3 kW). “3-6” should appear for all EL models running at 240VAC. “1-3” should appear for all EL models running at 120VAC, as well as all GL models. (\*A heater which is rated at 4 kW at 240VAC will function as a 1 kW heater at 120VAC.)
- If your system is using a special type of heater, a display such as “H 6” may appear next. If your system is using the generic Balboa heater, no heater type display will appear.
- “P” or “PRIMING MODE” will appear to signal the start of Priming Mode.

At this point, the power up sequence is complete. Refer to the User Guide for the ML Series panel on your system for information about how the spa operates from this point on.

# Wiring Configuration and DIP Settings

## Setup 1 (As Manufactured)

- 240V Pump 1, 2-Speed
- 240V Pump 2, 1-Speed
- 240V Circ Pump
- 120V Ozone
- 12V Spa Light
- 240V 5.5kW Heater
- ML400 Main Panel

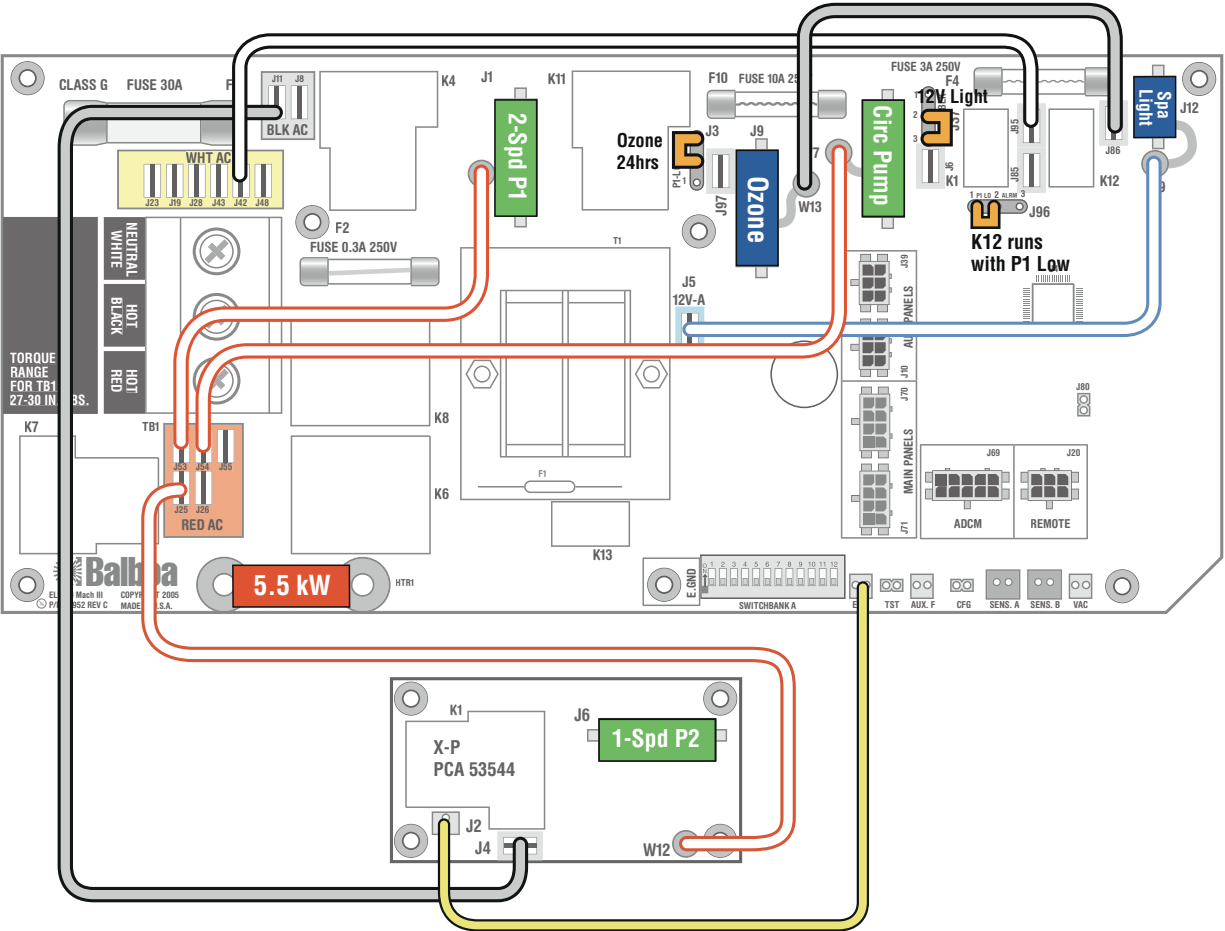

**WARNING:** Main Power to system should be turned OFF BEFORE adjusting DIP switches.  
**WARNING:** Persistent Memory (A12) must be RESET to allow new DIP switch settings to take effect. (See Persistent Memory page)

TST   
  AUX. F   
  CFG   
  SENS. A

When the Logic Jumper is not installed on J83 (CFG), DIP Switch Settings are enabled. DIP Switches will then operate as shown below.

SSID #  
 100  
 104  
 28

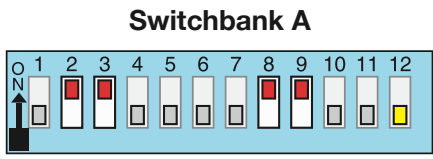

- A1, Test Mode OFF
- A2, High Amp
- A3, Filter by Duration
- A4, 12 Hr Time
- A5, Degrees F
- A6, Short Timeouts
- A7, Cleanup Cycles OFF
- A8, Pump 2 Enabled (A10 Off)
- A9, 24 hr Circ Pump
- A10, Blower Disabled
- A11, Do Not Use
- A12, Memory ON**

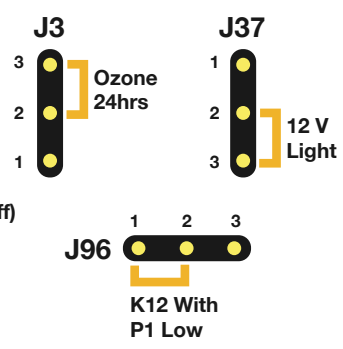

**Wiring Color Key**

- 120 Volt Connections
- 240 Volt Connections
- Black AC Jumpers
- 12 Volt Connections
- Relay Control Wires

**Connector Key**

Typically Line voltage  
 Typically Line voltage for 2-speed pumps  
 Neutral (Common)  
 Ground  
 Note flat sides in connector

# DIP Switches and Jumpers Definitions

**WARNING:**

- Setting DIP switches incorrectly may cause abnormal system behavior and/or damage to system components.
- Refer to Switchbank illustration on Wiring Configuration page for correct settings for this system.
- Contact Balboa if you require additional configuration pages added to this hot sheet.

**DIP Switchbank A Key**

- A 1 ..... Test Mode (normally Off)
- A 2 ..... In "ON" position, heater can run while any/all high-speed pumps or blowers are running. (High amperage)  
..... In "OFF" position, heater is disabled while any high-speed pump or blower is running. (Low amperage)
- A 3 ..... In "ON" position, filter cycles are programmed by duration  
..... In "OFF" position, filter cycles are programmed to start and end times
- A 4 ..... In "ON" position, displays time in 24 hours (military time)  
..... In "OFF" position, displays 12 hour time
- A 5 ..... In "ON" position, displays temperature in Celsius  
..... In "OFF" position, displays temperature in Fahrenheit
- A 6 ..... In "ON" position, Equipment timeout 30 minutes (4 hours for Pump 1 Low)  
..... In "OFF" position, Equipment timeout 15 minutes (2 hours for Pump 1 Low)
- A 7 ..... In "ON" position, Cleanup Cycle – 30 minutes after spa use/timeout, Pump 1 Low & Ozone run for 1 hour.  
..... In "OFF" position, no Cleanup Cycle
- A 8 ..... In "ON" position, enables Pump 2 (A10 must be Off)  
..... In "OFF" position, disables Pump 2
- A 9 ..... In "ON" position, DO NOT USE. \*See note below.  
..... In "OFF" position, no Circ Pump
- A 10 ..... In "ON" position, Blower enable when Pump 2 is disabled (A8 must be Off)  
..... In "OFF" position, Blower disabled
- A 11 ..... In "ON" position, DO NOT USE. \*See note below.  
..... In "OFF" position, Pump 1 is two-speed
- A 12 ..... Persistent memory reset (normally off) (used when spa is powering up)

---

**Jumpers**

- J3** Jumper on Pins 1 and 2 will power J9 (Ozone) with Pump 1 Low.  
Jumper on Pins 2 and 3 will power J9 to run 24 hours.
- J37** Jumper on Pins 1 and 2 will power one leg of J12 (Spa Light) at 120 Volts AC.  
Jumper on Pins 2 and 3 will power one leg of J12 (Spa Light) at 12 Volts AC.  
*Note: W9 controls voltage on the other leg of J12 and must be set for the same voltage.*
- J96** Jumper on Pins 1 and 2 will operate the relay K12 with Pump 1 Low.  
Jumper on Pins 2 and 3 will operate the relay K12 independently.

# Configuration Options

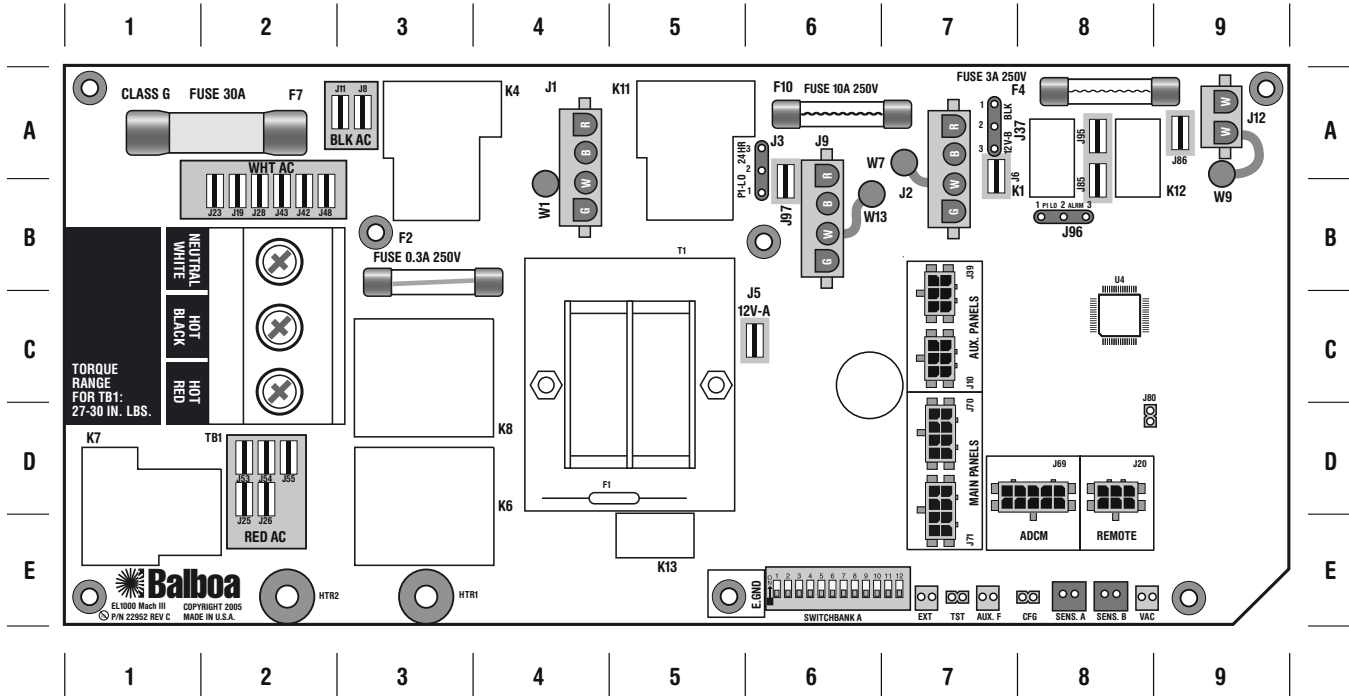

## Output Features

- J1 + W1 – 2-Speed Pump 1
- J2 + W7 – Audio/Visual
- J9 + W13 – Ozone (Separate Relay 120V or 240V)
- J12 + W9 – Spa Light (12V or 120V) Check J37 Setting

## Quadrant

- 4-A
- 7-C
- 6-B
- 9-A

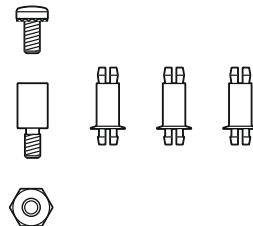

### X-Mount P

**PN 53933**

Used for mounting any Expander Board in a plastic enclosure. Standoffs attach to heater mounting bracket.

# Expander Options

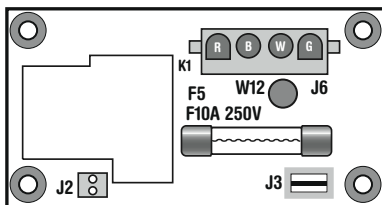

**X-B** **PN 53310**

Used for a Blower output ONLY.

- Cannot be used with X-P

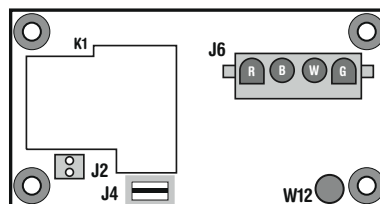

**X-P** **PN 53544**

Used for a 1-speed Pump 2 output ONLY.

- Cannot be used with X-B

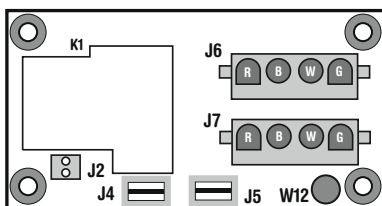

**X-03** **PN 53426**

Used for running Ozone and/or Circ Pump at voltage independent of Pump 1.

- Requires Adapter Cable PN 25339 to connect J4 on X-03 to J9 pin 1 (6-A) on main PCBA.
- Circ Pump and Ozone must be same voltage.

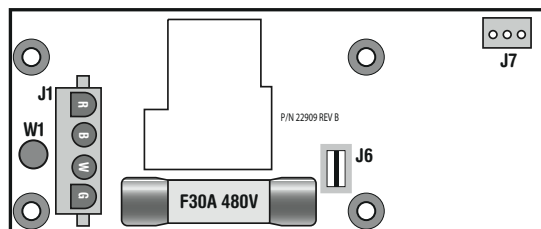

**X-P231** **PN 53681**

Can replace the X-P in cases where branch circuit protection is needed for high amperage devices that would over-burden power input fuse F7 (2-A) on the main PCBA. This allows J6 on the X-P231 to connect directly to Black AC (3-A) on the main EL1000 PCBA.

# Ozone Connections

## Ozone Connection Voltage:

Ozone Connection #1 - Using the J9 On-board Connector

- The EL1000 Circuit Board to deliver the desired voltage to the on-board connector (J9). Connect the W13 wire to J86 AND the wire from J95 to either White AC (120V) or Red AC (240V) to change the voltage setting if required.
- J3 should be set on pins 1 and 2 to operate the Ozone Generator with Pump 1 Low.

Ozone Connection #2 - Using X-03 Expansion Board

- An Ozone generator connected to the X-03 expansion board MUST be the same voltage as the circ pump connected.
- J3 should be set on pins 2 and 3 to provide continuous fused power to the X-03 expansion board from the J9 connector on the main PCBA.

## Balboa Ozone Generator:

The pin next to ground determines voltage on these connectors.

If the board is set up to operate a 120V ozone generator, the connector on the ozone generator is likely to be configured correctly, but should be compared to the illustration below.

If a 240V ozone generator is required, be sure the red wire in the ozone cord is positioned in the connector next to the green ground wire as described below.

*Note: A special tool is required to remove the pins from the connector body once they are snapped in place. Check with your Balboa Account Manager for information on purchasing a pin-removal tool.*

### Balboa Ozone connector configuration for 120V 60Hz

- Line - Black conductor
- Use this slot for the leftover Red conductor
- Common - Install the White conductor here for 120V ozone
- Ground (Green) conductor

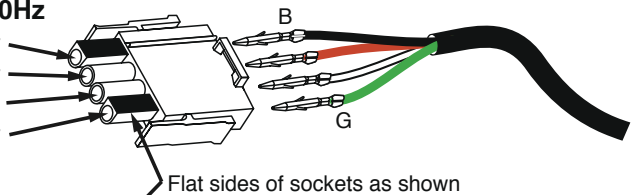

### Balboa Ozone connector configuration for 240V 60Hz

- Line - Black conductor
- Use this slot for the leftover White conductor
- Common - Install the Red conductor here for 240V ozone
- Ground (Green) conductor

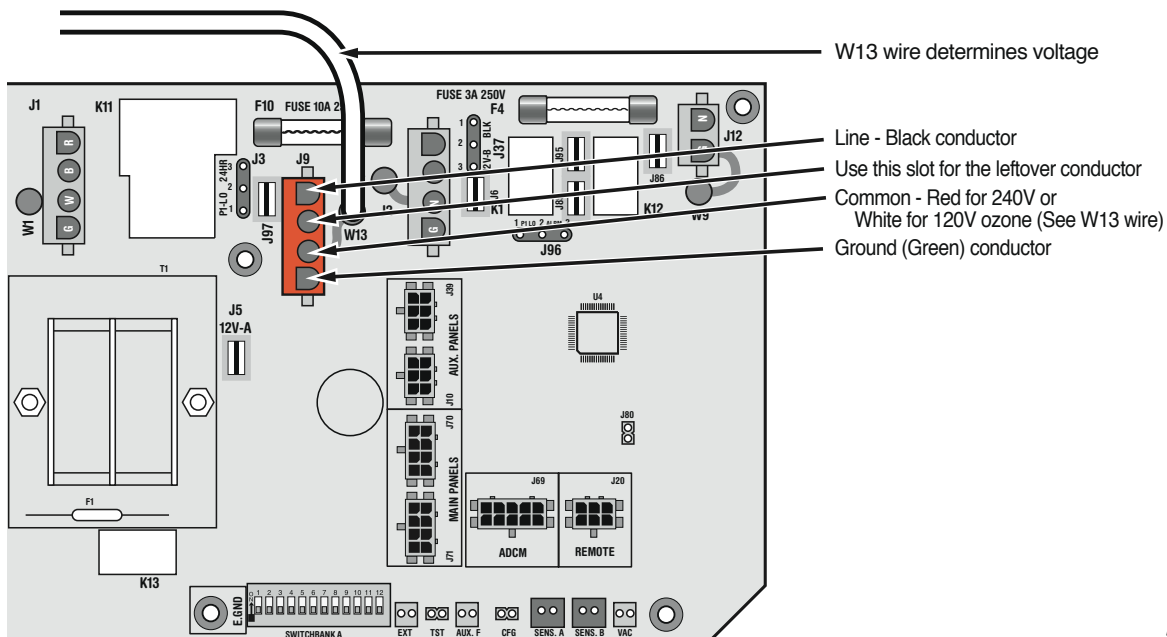
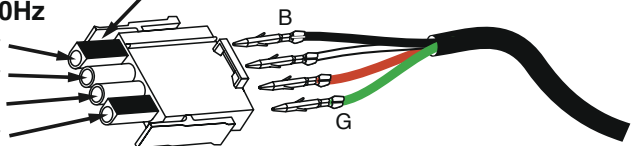



# Panel Configurations



**NON-TIME CAPABLE**

ML400

PN 52684 with Overlay PN 11345

- Connects to Main Panel terminal J70 or J71