

# EL84P Mach 3 Tech Sheet

## Balboa Instruments System PN 54775

System Model # EL8-EL84P-YCAH

Software Version # 32

EPN # 2756

Base PCBA – PN 55889

PCB EL8000 – PN 22041 Rev A

HEX File – 10013432\_EL84P\_02.hex

Configuration Signature – 513BFF57

### Base Panels

ML900 – PN 54589

### Aux Panels

AX10A3 – PN 52765

### Optional Base Panel

MLM990S – PN 54527-02

Requires ADCM Splitter to be installed.

### Aux Panels

AX40 – PN 55487



# System Revision History

System PN	EPN	Date	Requested By	Changes Made
54775	2756	02.11.2008	Balboa	New system at v31
54775	2756	04.24.2008	Balboa	Update to v32
54775	2756	06.04.2008	Balboa	Pages 1 & 19: AX40 panel = PN 55487
54775	2756	09.10.2008	Balboa	New Config file - Change expander board
54775	2756	09.17.2008	Balboa	New Config file - Aux Behavior on DIP Switches



# Persistent Memory and Powering Up

Any time you change DIP Switches or Software Configuration Settings that affect parameters the user can change (any filter settings, set temperature default, Celsius vs Fahrenheit, 12-hour vs 24-hour time, reminders suppression, etc), you must reset Persistent Memory for your DIP Switch or Software Configuration Settings changes to take effect. You should also reset Persistent Memory after loading a new file into a board (using the ESM, purchased separately).

## To reset Persistent Memory:

- Power down.
- Set A12 ON (See illustration below).
- Power up.
- Wait until “P” or “PRIMING MODE” is displayed on your panel.  
Note: If “CFE” appears see section below.
- Set A12 OFF. (This can be done safely with power on if you use a non-conductive tool such as a pencil to push the switch back to the OFF position. Otherwise, power down before setting A12 OFF)
- Power up again (if you powered down in the previous step).
- For all other power ups, leave A12 OFF

## About Persistent Memory and Time of Day Retention:

This system uses memory that doesn't require a battery to store a variety of settings. What we refer to as Persistent Memory stores all the User Preferences, as well as all the filter settings, the set temperature, and the heat mode.

Persistent Memory is not used for Time of Day. Time of Day needs to be “kept running” (not just stored) while the power is off, so a separate Real Time Clock feature (on all models except the EL1000) keeps track of Time of Day while the unit is off. Time of Day Retention, and Time of Day Retention alone, is controlled by the J91 jumper. J91 must be set according to main system panel used.

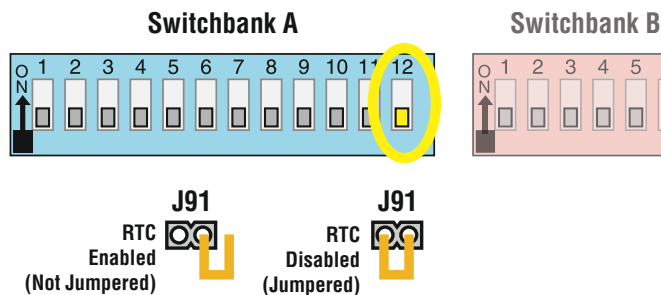

## CFE message on power up:

If “CFE” appears before (and instead of) “P” or “PRIMING MODE”, you have not configured DIP Switches and/or Software Configuration Settings in a valid manner. This must be corrected before you can reset Persistent Memory.

The switch numbers, jumpers, or configuration settings displayed after “CFE” are ones with which the system has found a configuration problem.

For example:

- “CFE A5 B2” would mean that the combination of how you've set A5 and how you've set B2 is not supported on this system.
- “CFE J99” would mean that there is a problem with jumper J99
- “CFE P3 1 BL 1” would mean that the combination of how you've set pump 3 for 1-speed and blower for 1-speed is not supported on this system.
- “CFE P3\_ BL\_” would mean that the combination of how you've set DIP switches which have been assigned to pump 3 and blower is not supported on this system.

## Power Up Display Sequence

Upon power up, you should see the following on the display:

- Three numbers in a row, which are the SSID (the System Software ID). The third display of these numbers is the Software Version, which should match the version of your system. For example, if these three numbers are 100 134 26, that is a Mach 3 EL8000 at version 26.
- If there is a Configuration Error, the CFE message (see above) will appear at this point (and none of the messages below will display). Otherwise what comes next is:
- An indication of either the input voltage detected (EL1000/EL2000), or the heater wattage range supported (EL8000/GL2000/GL8000).
  - Heater wattage display: “1-3” means the system supports a heater from 1 kW to 3 kW. “3-6” means the system supports a heater from 3 kW to 6 kW. “3-3” means the system supports a 3 kW heater only. (These ranges may be modified slightly in the case of special heaters, which the next bullet covers.)
- Input voltage display: A system showing “240” supports 3 kW to 6 kW heaters. A system showing “120” supports the very same heaters, although at 120V those heaters will function at only 1/4 of their 240V rated wattage. (The system shows only either “240” or “120” as a general indication of input voltage; it does not show the actual input voltage.)
- If your system is using a special type of heater, a display such as “H B” may appear next. If your system is using the generic Balboa heater, no heater type display will appear.
- “P” or “PRIMING MODE” will appear to signal the start of Priming Mode.

At this point, the power up sequence is complete. Refer to the User Guide for the ML Series panel on your system for information about how the spa operates from this point on.

# Wiring Configuration and DIP Settings

## Setup 1 (As Manufactured)

- 240V Pump 1, 2-Speed
- 240V Pump 2, 2-Speed
- 240V Pump 3, 1-Speed
- 240V Pump 4, 1-Speed on X-P632
- 12V Spa Light
- 120V Fiber w/ wheel
- 120V Ozone
- 120V AV (Stereo)
- "Continuity Momentary" TV Lift
- 240V 5.5kW Heater
- 240V Circ Pump (optional)
- 240V Blower (optional)
- ML900 Main Panel
- AX10A3 Panel - Required for Blower control

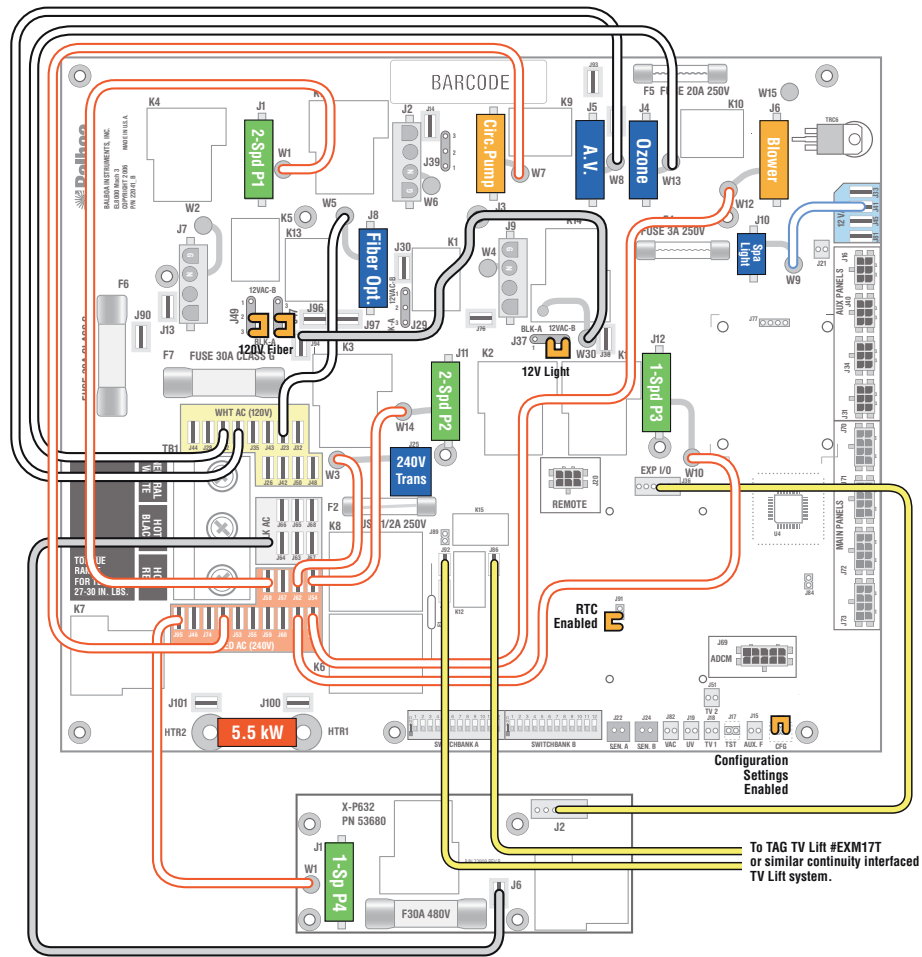

To TAG TV Lift #EXM177 or similar continuity interfaced TV Lift system.

**WARNING:** Main Power to system should be turned OFF BEFORE adjusting DIP switches.  
**WARNING:** Persistent Memory (A12) must be RESET to allow new DIP switch settings to take effect. (See Persistent Memory page)

### Switchbank A

1	2	3	4	5	6	7	8	9	10	11	12
ON											

A1, Test Mode OFF  
A2, + 1 Pump w/Heat  
A3, + 2 Pumps w/Heat  
A4,  
A5, } See Table 1  
A6, } Circ Behavior

### Switchbank B

1	2	3	4	5	6	7	8	9	10	11	12
ON											

B1, See Table 3  
B2, Blower on AX10A3  
B3, Not Assigned  
B4, Not Assigned  
B5, Not Assigned  
B6, Not Assigned

SSID #

100
134
32

### Wiring Color Key

- 120 Volt Connections
- 240 Volt Connections
- Black AC Jumpers
- 12 Volt Connections
- Relay Control Wires

### Board Connector Key

1	Typically Line voltage
2	Typically Line voltage for 2-speed pumps
3	Neutral (Common)
4	Ground

Note flat sides in connector

<p>J49 J47</p> <p>120V/240V Fiber Light and Wheel</p>	<p>J29</p> <p>J9 Black AC</p>	<p>J39</p> <p>J2 with Pump 1 Low</p>	<p>J37 Spa Light 12V</p>	<p>RTC Enabled</p> <p>J91</p>	<p>Config Settings Enabled</p> <p>J83</p>
---	-------------------------------	--------------------------------------	--------------------------	-------------------------------	---

# Wiring Configuration and DIP Settings

## Setup 2

- 240V Pump 1, 2-Speed
- 240V Pump 2, 2-Speed
- 240V Pump 3, 1-Speed
- 240V Pump 4, 1-Speed on X-P632
- 12V Spa Light
- 120V Fiber w/ wheel
- 120V Ozone
- 120V AV (Stereo)
- "Continuity Momentary" TV Lift
- 240V 5.5kW Heater
- 240V Circ Pump (optional)
- 240V Blower (optional)
- MLM990S Main Panel
- ADCM Splitter
- AX40 Panel -  
*Required for Jets 3 and Jets 4 Buttons*

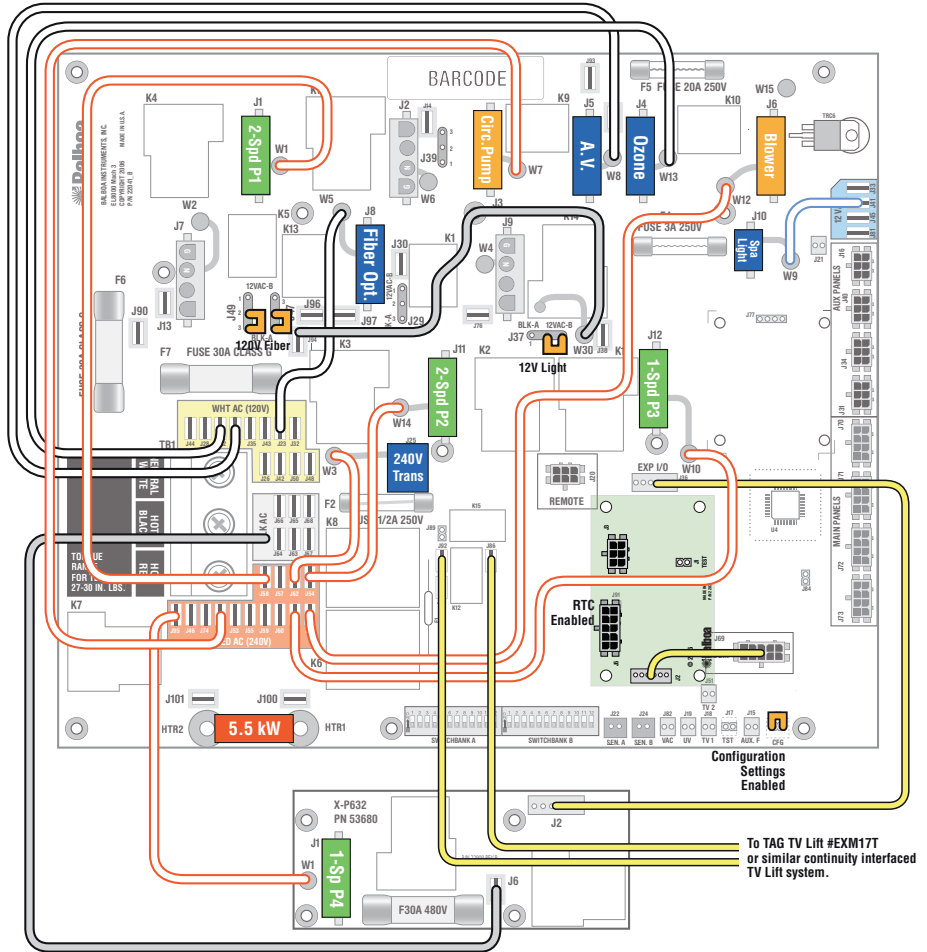

To TAG TV Lift #EXM17T or similar continuity interfaced TV Lift system.

**WARNING:** Main Power to system should be turned OFF BEFORE adjusting DIP switches.  
**WARNING:** Persistent Memory (A12) must be RESET to allow new DIP switch settings to take effect. (See Persistent Memory page)

### Switchbank A

1	2	3	4	5	6	7	8	9	10	11	12
ON											

A1, Test Mode OFF  
A2, + 1 Pump w/Heat  
A3, + 2 Pumps w/Heat  
A4,  
A5, } See Table 1  
A6, } Circ Behavior

A7, } See Table 2  
A8, } Blower  
A9, See Table 3  
A10, No Edit  
A11, Special Amp Rule OFF  
A12, Memory ON

### Switchbank B

1	2	3	4	5	6	7	8	9	10	11	12
ON											

B1, See Table 3  
B2, AX40 - J1, J2, J3, J4  
B3, Not Assigned  
B4, Not Assigned  
B5, Not Assigned  
B6, Not Assigned

B7, Not Assigned  
B8, Not Assigned  
B9, Not Assigned  
B10, Not Assigned  
B11, Not Assigned  
B12, Not Assigned

### SSID #

100
134
32

### Wiring Color Key

- 120 Volt Connections
- 240 Volt Connections
- Black AC Jumpers
- 12 Volt Connections
- Relay Control Wires

### Board Connector Key

1	Typically Line voltage
2	Typically Line voltage for 2-speed pumps
3	Neutral (Common)
4	Ground

Note flat sides in connector

### Connector Diagrams

<p>J49 J47</p> <p>1 2 3</p> <p>120V/240V Fiber Light and Wheel</p>	<p>J29</p> <p>1 2 3</p> <p>J9 Black AC</p>	<p>J39</p> <p>1 2 3</p> <p>J2 with Pump 1 Low</p>	<p>J37 Spa Light 12V</p> <p>1 2 3</p>	<p>RTC Enabled</p> <p>J91</p>	<p>Config Settings Enabled</p> <p>J83</p>
--	--	---	---------------------------------------	-------------------------------	---

# DIP Switches Definitions

**WARNING:**

- Setting DIP switches incorrectly may cause abnormal system behavior and/or damage to system components.
- Refer to Switchbank illustration on Wiring Configuration page for correct settings for this system.
- Contact Balboa if you require additional configuration pages added to this tech sheet.

**DIP Switchbank A Key**

- A1 ..... Test Mode (normally Off)
- A2 ..... In "ON" position, add one high-speed pump (or blower) with Heater
- A3 ..... In "ON" position, add two high-speed pumps (or 1 HS Pump and Blower) with Heater
- A4 ..... In "ON" position, add four high-speed pumps (or 3 HS Pumps and Blower) with Heater
- A10 ..... When switched ON when spa is on, system will enter the Edit Menu for Configuration Settings  
**Do not start spa with A10 turned on or CFE\* error will occur**
- A11 ..... In "ON" position, enables Special Amperage Rule, see "SA" in Software Configuration section for functionality with your system  
 ..... In "OFF" position, disables Special Amperage Rule
- A12 ..... Persistent memory reset (used when spa is powering up) See "Persistent Memory and Powering Up" page

A2, A3, and A4 work in combination to determine the number of high-speed devices and blowers that can run before the heat is disabled. i.e. A2 and A3 in the ON position and A4 in the OFF position will allow the heater to operate with up to 3 high-speed pumps (or two HS Pumps and Blower) running at the same time. Heat is disabled when the fourth high-speed pump or blower is turned on.

*Note: A2/A3/A4 all off = No heat with any high-speed pump or blower.*

\*CFE errors are illegal configurations such as a pump and a blower set to run on the same output. The configuration must be corrected before the spa will operate.

**Assignable DIP Switch Key**

- A5 and A6..... See **Table 1** for Circ Pump Behavior settings
- A7 and A8..... See **Table 2** for Blower Behavior settings
- A9 ..... See **Table 3** For TV Lift Settings
- B1 ..... See **Table 3** For TV Lift Settings
- B2 ..... In "ON" position, AX40 = J1, J2, J3, J4 — AX10A3 = Blower  
 ..... In "OFF" position, AX40 = J1, J2, J3, J4
- B3 ..... Not Assigned
- B4 ..... Not Assigned
- B5 ..... Not Assigned
- B6 ..... Not Assigned
- B7 ..... Not Assigned
- B8 ..... Not Assigned
- B9 ..... Not Assigned
- B10 ..... Not Assigned
- B11 ..... Not Assigned
- B12 ..... Not Assigned

<i>Table 1</i>		<b>Circ Pump Behavior</b>
<b>A5</b>	<b>A6</b>	
OFF	OFF	Non-Circ
OFF	ON	24hr Circ
ON	OFF	24hr with 3°F
ON	ON	Like P1-low

<i>Table 2</i>		<b>Blower Behavior</b>
<b>A7</b>	<b>A8</b>	
OFF	OFF	No Blower
OFF	ON	1-Spd Blower
ON	OFF	2-Spd Blower
ON	ON	3-Spd Blower

<i>Table 3</i>		<b>TV Lift Behavior</b>
<b>A9</b>	<b>B1</b>	
OFF	OFF	No TV Lift
OFF	ON	Toggle
ON	OFF	Momentary

# Jumper Definitions

**WARNING:**

- Setting DIP switches incorrectly may cause abnormal system behavior and/or damage to system components.
- Refer to Switchbank illustration on Wiring Configuration page for correct settings for this system.
- Contact Balboa if you require additional configuration pages added to this tech sheet.

## Jumpers Key

- J29 . . . . . Jumper on Pins 1 and 2 will power J9-pin 1 (Mister) at 12 Volts AC.  
Jumper on Pins 2 and 3 will power J9-pin 1 (Mister) at 120/240 Volts AC.  
*Note: W4 controls voltage on return line of J9-pin 3 and must be set for the same voltage.*
- J37 . . . . . Jumper on Pins 1 and 2 will power one leg of J10-pin 2 (Spa Light) at 120/240 Volts AC.  
Jumper on Pins 2 and 3 will power one leg of J10-pin 2 (Spa Light) at 12 Volts AC.  
*Note: W9 controls voltage on the return line of J10-pin 1 and must be set for the same voltage.*
- J39 . . . . . Jumper on Pins 1 and 2 will power J2 pin 2 with Pump 1 Low.  
Jumper on Pins 2 and 3 will power J2 pin 2 with the Circ Pump.  
*Note: W6 controls voltage on common line of J2-pin 3*
- J47 . . . . . Jumper on Pins 1 and 2 will power J8 pin 2 (Fiber Optic Light) and J7 at 120/240 Volts AC.  
Jumper on Pins 2 and 3 will power J8 pin 2 (Fiber Optic Light) at 12 Volts AC.  
*Note: J47 and J49 must be set for the same voltage. W5 controls voltage on return line of J8-pin 3 and must be set to the same voltage.*
- J49 . . . . . Jumper on Pins 2 and 3 will power J8 pin 1 (Fiber Optic Wheel) at 120/240 Volts AC.  
Jumper on Pins 1 and 2 will power J8 pin 1 (Fiber Optic Wheel) at 12 Volts AC.  
*Note: J47 and J49 must be set for the same voltage. W5 controls voltage on return line of J8-pin 3 and must be set to the same voltage.*
- J91 . . . . . Jumper on 1 Pin only enables Real Time Clock function, for use with time capable panels.  
Jumper on Pins 1 and 2 will disable RTC function, for use with non-time capable panels.



# Software Configuration Settings

**n** = OEM Setting (Green circle)

<b>Fd</b>	Program Filter Cycles by Duration	<b>n</b> Y _ <b>n</b> = Start and stop times; for time capable panels. <b>Y</b> = Duration; for non-time capable panels <b>_</b> = 1 DIP Switch	
<b>F1</b>	Pump 1 in Filter (w/Circ Pump)	<b>n</b> Y (This feature is used in Circ Mode only.) Allows Pump 1 Low to operate in Filter Cycles to add extra filtration. <b>n</b> = Normal; <b>Y</b> = Pump 1 with Circ	
<b>24</b>	24-Hour Time*	<b>n</b> Y _ <b>n</b> = 12-hour (am/pm); <b>Y</b> = 24-hour (military/European); <b>_</b> = 1 DIP Switch *Sets default for user preferences - only applies when persistent memory is reset (A12 On) during power-up.	
<b>tc</b>	Celsius**	<b>n</b> Y _ <b>n</b> = Fahrenheit; <b>Y</b> = Celsius; <b>_</b> = 1 DIP Switch **Sets default for user preferences - only applies when persistent memory is reset (A12 On) during power-up	
<b>to</b>	Timeouts	1 <b>F</b> 2 3 4 5 6 <b>1-6</b> = 10, 20, 30, 40, 50, 60 minutes; <b>F</b> = 15 minutes	
<b>1t</b>	Pump 1 Low Timeout	d 1 <b>2</b> 3 4 _ <b>d</b> = Use "Timeouts" value above; <b>1-4</b> = number of hours; <b>_</b> = 3 DIP Switch	
<b>Lt</b>	Light Timeout	d 1 2 3 <b>4</b> <b>d</b> = Use "Timeouts" value above; <b>1-4</b> = number of hours	
<b>Sc</b>	Scrunch Panel	<b>n</b> Y _ <b>n</b> = Normal panel layout; <b>Y</b> = Alternate panel layout (ML900 scrunching enabled - ML550/700 Jets 3 replaces Blower; <b>_</b> = 1 DIP Switch	
<b>ct</b>	Circ Type (behavior)	n A 3 P <b>_</b> <b>n</b> = Non circ or circ pump not plumbed with heater; <b>A</b> = 24-hour; <b>3</b> = 24-hour with 3°F shutoff outside filter; <b>P</b> = Acts like Pump 1 Low (filter cycles, polls, etc.); <b>_</b> = 2 DIP Switch	
<b>PUMP SPEEDS</b>	<b>P1</b>	Pump 1 Speeds	1 <b>2</b> _ <b>1</b> = 1 speed; <b>2</b> = 2 speed; <b>_</b> = 1 DIP Switch
	<b>P2</b>	Pump 2 Speeds	0 1 <b>2</b> _ <b>0</b> = Disabled; <b>1</b> = On/Off; <b>2</b> = 2 speed; <b>_</b> = 2 DIP Switch
	<b>P3</b>	Pump 3 Speeds	0 <b>1</b> 2 _ <b>0</b> = Disabled; <b>1</b> = On/Off; <b>2</b> = 2 speed; <b>_</b> = 3 DIP Switch
	<b>P4</b>	Pump 4 Speeds	0 1 E <b>H</b> L _ <b>0</b> = Disabled; <b>1</b> = On/Off on board; <b>E</b> = External X-P or X-P231 board <b>H</b> = On/Off on pin 1 of X-P632 board; <b>L</b> = 2 speed on X-P632 board; <b>_</b> = 3 DIP Switch
	<b>P5</b>	Pump 5 Speeds	<b>0</b> 1 E L _ <b>0</b> = Disabled; <b>1</b> = On/Off on board; <b>E</b> = External X-P or X-P231 board <b>L</b> = On/Off on pin 2 of X-P632 board; <b>_</b> = 2 DIP Switch

# Software Configuration Settings Continued

<b>PUMP SPEEDS</b>	<b>P6</b>	Pump 6 Speeds	<input checked="" type="radio"/> 0 1 _ 0 = Disabled; 1 = On/Off; _ = 1 DIP Switch									
	<b>bL</b>	Blower Speeds	0 1 2 3 <input checked="" type="radio"/> 0 = Disabled; 1 = On/Off; 2 = 2 speeds; 3 = 3 speeds; _ = 2 DIP Switch									
<b>LIGHTING CONTROL</b>	<b>Lb</b>	Separate Spa Light Buttons (This feature applies when using Fiber Optic light)	<input checked="" type="radio"/> Y _ See Chart Below n = No Spa light button, Spa Light output is on with Fiber; Y = Separate Spa Light button on ML900 or Aux panel _ = 1 DIP Switch									
		<p><i>Note: The Light button on an ML900 panel is a SpaLight button. The Light button on most other panels is an EitherLight button.</i></p> <table border="1"> <thead> <tr> <th></th> <th>Lb.n</th> <th>Lb.Y</th> </tr> </thead> <tbody> <tr> <td><b>Fo.n</b></td> <td>No separately-controlled fiber light; spa light enabled on both SpaLight and EitherLight buttons; fiber light (not wheel) comes on with spa light (at any intensity)</td> <td></td> </tr> <tr> <td><b>Fo.Y</b></td> <td>No separately-controlled fiber light; fiber light enabled on both FiberLight and EitherLight buttons; spa light comes on with fiber light</td> <td>Spa light and fiber light each separately controlled; fiber light enabled on both FiberLight and EitherLight buttons; spa light enabled on SpaLight buttons only</td> </tr> </tbody> </table>			Lb.n	Lb.Y	<b>Fo.n</b>	No separately-controlled fiber light; spa light enabled on both SpaLight and EitherLight buttons; fiber light (not wheel) comes on with spa light (at any intensity)		<b>Fo.Y</b>	No separately-controlled fiber light; fiber light enabled on both FiberLight and EitherLight buttons; spa light comes on with fiber light	Spa light and fiber light each separately controlled; fiber light enabled on both FiberLight and EitherLight buttons; spa light enabled on SpaLight buttons only
		Lb.n	Lb.Y									
<b>Fo.n</b>	No separately-controlled fiber light; spa light enabled on both SpaLight and EitherLight buttons; fiber light (not wheel) comes on with spa light (at any intensity)											
<b>Fo.Y</b>	No separately-controlled fiber light; fiber light enabled on both FiberLight and EitherLight buttons; spa light comes on with fiber light	Spa light and fiber light each separately controlled; fiber light enabled on both FiberLight and EitherLight buttons; spa light enabled on SpaLight buttons only										
<b>L 1</b>	Spa Light On/Off	<input checked="" type="radio"/> Y _ n = Dimmable (H, M, L) Light; Y = On/Off Light; _ = 1 DIP Switch										
	<b>Fo</b>	Fiber Optics	<input checked="" type="radio"/> Y _ n = Disabled; Y = Light and Wheel Enabled;; _ = 2 DIP Switch									
	<b>15</b>	Mister	<input checked="" type="radio"/> Y _ n = Mister Disabled (Option Enabled on J9); Y = Mister Enabled on J9 (Option Disabled); _ = 1 DIP Switch									
<b>OPTIONS</b>	<b>01</b>	Option 1*	<input checked="" type="radio"/> Y P _ n = Disabled; Y/P = Enabled on J9; _ = 2 DIP Switch									
	<b>02</b>	Option 2*	<input checked="" type="radio"/> Y P <input checked="" type="radio"/> n = Disabled; Y/P = Enabled on "alarm" relay; _ = 2 DIP Switch									
	<b>03</b>	Option 3*	<input checked="" type="radio"/> Y P _ n = Disabled; Y/P = Enabled on pin 1 of X-P632 board; _ = 2 DIP Switch									
	<b>04</b>	Option 4*	<input checked="" type="radio"/> Y P _ n = Disabled; Y/P = Enabled on pin 2 of X-P632 board; _ = 2 DIP Switch									
	<b>05</b>	Option 5*	<input checked="" type="radio"/> Y P _ n = Disabled; Y/P = Enabled on J7; _ = 2 DIP Switch									
		*Note: Options 1-5: Y = On/Off w/no timeout (toggle) mode; P = Pulse (momentary) mode										
	<b>CC</b>	Cleanup Cycles**	<input checked="" type="radio"/> 0 1 2 3 4 0 = Disabled; 1-4 = Number of hours									
		**Sets default for user preferences - only applies when persistent memory is reset (A12 On) during power-up.										
	<b>CU</b>	Cleanup Cycles as User Preference	<input checked="" type="radio"/> Y n = Only in Configuration Settings; Y = Over-rideable by User via User Preferences									

# Software Configuration Settings Continued

<b>OZONE</b>	o3	Ozone Operation	<b>A</b> F _ <b>A</b> = Operates with Heater Pump (Pump 1 Low or Circ Pump); <b>F</b> = Operates in Filter and Cleanup Cycles only; _ = 1 DIP Switch
	o5	Ozone Suppression	<b>n</b> Y _ <b>n</b> = No Suppress; <b>Y</b> = 1-hour suppress on button press; _ = 1 DIP Switch
	o1	Ozone Icon	n Y <b>U</b> <b>n</b> = Disabled; <b>Y</b> = Enabled ; <b>U</b> = Controlled by UV input
<b>AUXILIARY BUTTONS</b>	A1	Aux Button 1 (Bank A)	<b>1</b> 2 3 4 5 6 b g F E o t d P n A U r O H 9 L 8 7
	A2	Aux Button 2 (Bank A)	1 <b>2</b> 3 4 5 6 b g F E o t d P n A U r O H 9 L 8 7
	A3	Aux Button 3 (Bank A)	1 2 <b>3</b> 4 5 6 b g F E o t d P n A U r O H 9 L 8 7
	A4	Aux Button 4 (Bank A)	1 2 3 <b>4</b> 5 6 b g F E o t d P n A U r O H 9 L 8 7
	<b>1-6</b> = Assigns Pump Number (Pump 1, Pump 2, etc); <b>b</b> = Blower; <b>g</b> = Spa Light; <b>F</b> = Fiber-Optic wheel/light; <b>E</b> = EitherLight; <b>o</b> = Option 1; <b>t</b> = Mister; <b>d</b> = CK Mode/Cool; <b>P</b> = CK Option/Heat; <b>n</b> = CK Intensity/TurboHt; <b>A</b> = ACD Aroma/Sound Mode Select; <b>U</b> = Button Disabled; <b>r</b> = Air Valve; <b>O</b> = Option 2; <b>H</b> = Option 3; <b>9</b> = Invert; <b>L</b> = Option 4; <b>8</b> = Stir; <b>7</b> = Option 5		
	b1	Aux Button 1 (Bank B)	<b>1</b> 2 3 4 5 6 b g F E o t d P n A U r O H 9 L 8 7
	b2	Aux Button 2 (Bank B)	1 <b>2</b> 3 4 5 6 b g F E o t d P n A U r O H 9 L 8 7
	b3	Aux Button 3 (Bank B)	1 2 3 4 5 6 <b>b</b> g F E o t d P n A U r O H 9 L 8 7
	b4	Aux Button 4 (Bank B)	1 2 3 4 5 6 b g F <b>E</b> o t d P n A U r O H 9 L 8 7
	<b>1-6</b> = Assigns Pump Number (Pump 1, Pump 2, etc); <b>b</b> = Blower; <b>g</b> = Spa Light; <b>F</b> = Fiber-Optic wheel/light; <b>E</b> = EitherLight; <b>o</b> = Option 1; <b>t</b> = Mister; <b>d</b> = CK Mode/Cool; <b>P</b> = CK Option/Heat; <b>n</b> = CK Intensity/TurboHt; <b>A</b> = ACD Aroma/Sound Mode Select; <b>U</b> = Button Disabled; <b>r</b> = Air Valve; <b>O</b> = Option 2; <b>H</b> = Option 3; <b>9</b> = Invert; <b>L</b> = Option 4; <b>8</b> = Stir; <b>7</b> = Option 5		
AU	Aux Button Bank Select	A b <b>_</b> <b>A</b> = Bank A; <b>b</b> = Bank B; _ = 1 DIP Switch	
<b>REMINDERS</b>	sr	Suppress all Reminders	n <b>Y</b> _ <b>n</b> = Display Reminders; <b>Y</b> = Suppress all Reminders; _ = 1 DIP Switch
	rP	Check pH Reminder Period	0 <b>1</b> 2 3 4 5 6 7 8 9 t
	rS	Check Sanitizer Reminder Period	0 <b>1</b> 2 3 4 5 6 7 8 9 t
	rF	Clean Filter Reminder Period	0 1 2 <b>3</b> 4 5 6 7 8 9 t
	rG	Test GFCI Reminder Period	0 1 2 <b>3</b> 4 5 6 7 8 9 t
	rd	Drain Water Reminder Period	0 1 2 3 4 5 <b>6</b> 7 8 9 t
	rA	Change Mineral Cartridge	<b>0</b> 1 2 3 4 5 6 7 8 9 t
	rC	Clean Cover Reminder Period	0 1 2 3 4 5 6 7 <b>8</b> 9 t
	ro	Treat Wood Reminder Period	0 1 2 3 4 5 6 7 <b>8</b> 9 t
	rt	Change Filter Reminder Period	0 1 2 3 4 5 6 7 8 <b>9</b> t
<b>0</b> = Off; <b>1</b> = 7 days; <b>2</b> = 14 days; <b>3</b> = 30 days; <b>4</b> = 45 days; <b>5</b> = 60 days; <b>6</b> = 90 days; <b>7</b> = 120 days; <b>8</b> = 180 days; <b>9</b> = 365 days; <b>t</b> = 21 days			

# Software Configuration Settings Continued

**LS** Lowest Set Temperature\* **8** 7  
**8** = 80°F/26.0°C; **7** = 70°F/21.0°C

\*Setting LS at 7 and Fr at 5 will cause a CFE error.

**St** Default Set Temperature\*\* 5 6 7 8 9 **0** 1 2 3 4 E F n  
**5** = 95°F/35.0°C; **6** = 96°F/35.5°C; **7** = 97°F/36.0°C; **8** = 98°F/36.5°C; **9** = 99°F/37.0°C; **0** = 100°F/38.0°C;  
**1** = 101°F/38.5°C; **2** = 102°F/39.0°C; **3** = 103°F/39.5°C; **4** = 104°F/40.0°C; **E** = 80°F/26.5°C; **F** = 85°F/29.5°C  
**n** = 90°F/32.0°C

\*\*Sets default for user preferences - only applies when persistent memory is reset (A12 On) during power-up.

**Fr** Freeze Temperature Threshold 3 **4** 9 5  
**3** = 39°F/3.9°C; **4** = 44°F/6.7°C; **9** = 49°F/9.4°C; **5** = 54°F/12.2°C;

**tL** Set Temperature Lock **t** S  
**t** = Temp Lock Only; **S** = Temp + Settings Lock

**Lc** Light Cycle Programming **n** Y  
**n** = Disabled; **Y** = Enabled

**1r** Filter 1 Start Hour (Set 1)\*\*\* **-** 0 1 2 3 4 5 6 7 8 9 A b C d E F g H J L n o P r  
**1d** Filter 1 Duration (Set 1)\*\*\* **-** 0 1 2 3 4 5 6 7 8 9 A b C d E F g H J L n o P r  
**2r** Filter 2 Start Hour (Set 1)\*\*\* **-** 0 1 2 3 4 5 6 7 8 9 A b C d E F g H J L n o P r  
**2d** Filter 2 Duration (Set 1)\*\*\* **-** 0 1 2 3 4 5 6 7 8 9 A b C d E F g H J L n o P r

- = Standard Defaults; **0** = 0 (12 am, 24); **1-9** = 1-9; **A** = 10; **b** = 11; **C** = 12; **d** = 13 (1 pm); **E** = 14 (2 pm);  
**F** = 15 (3 pm); **g** = 16 (4 pm); **H** = 17 (5 pm); **J** = 18 (6 pm); **L** = 19 (7 pm); **n** = 20 (8 pm); **o** = 21 (9 pm);  
**P** = 22 (10 pm); **r** = 23 (11 pm)

These settings allow customization of the filter defaults. If any of these four settings is "-", the standard filter defaults are used.

**1d** and **2d** cannot both be set to **0**.

When **Fd.n** is selected, **1d** and **2d** are Filter 1 and Filter 2 Duration specifically.

When **Fd.y** is selected:

If **1d** is set to **0**, **2d** is the duration; otherwise **1d** is the duration.

If **1d** is set to **0**, only the Night cycle runs.

If **2d** is set to **0**, only the Day cycle runs.

If neither **1d** nor **2d** is set to **0**, both the Day and Night cycles run.

\*\*\*Sets default for user preferences - only applies when persistent memory is reset (A12 On) during power-up.

## FILTER CYCLES

# Software Configuration Settings Continued

FILTER CYCLES			
3r	Filter 1 Start Hour (Set 2)*	-	0 1 2 3 4 5 6 7 8 9 A b C d E F g H J L n o P r
3d	Filter 1 Duration (Set 2)*	-	0 1 2 3 4 5 6 7 8 9 A b C d E F g H J L n o P r
4r	Filter 2 Start Hour (Set 2)*	-	0 1 2 3 4 5 6 7 8 9 A b C d E F g H J L n o P r
4d	Filter 2 Duration (Set 2)*	-	0 1 2 3 4 5 6 7 8 9 A b C d E F g H J L n o P r
<p>- = Standard Defaults; <b>0</b> = 0 (12 am, 24); <b>1-9</b> = 1-9; <b>A</b> = 10; <b>b</b> = 11; <b>C</b> = 12; <b>d</b> = 13 (1 pm); <b>E</b> = 14 (2 pm); <b>F</b> = 15 (3 pm); <b>g</b> = 16 (4 pm); <b>H</b> = 17 (5 pm); <b>J</b> = 18 (6 pm); <b>L</b> = 19 (7 pm); <b>n</b> = 20 (8 pm); <b>o</b> = 21 (9 pm); <b>P</b> = 22 (10 pm); <b>r</b> = 23 (11 pm)</p> <p>These settings allow customization of the filter defaults. If any of these four settings is "-", the standard filter defaults are used.</p> <p><b>3d</b> and <b>4d</b> cannot both be set to <b>0</b>.</p> <p>When <b>Fd.n</b> is selected, <b>3d</b> and <b>4d</b> are Filter 1 and Filter 2 Duration specifically.</p> <p>When <b>Fd.y</b> is selected:            If <b>3d</b> is set to <b>0</b>, <b>4d</b> is the duration; otherwise <b>3d</b> is the duration.            If <b>3d</b> is set to <b>0</b>, only the Night cycle runs.            If <b>4d</b> is set to <b>0</b>, only the Day cycle runs.            If neither <b>3d</b> nor <b>4d</b> is set to <b>0</b>, both the Day and Night cycles run.</p> <p>*Sets default for user preferences - only applies when persistent memory is reset (A12 On) during power-up.</p>			
FS	Filter Default Start Time Set**	1	2 _
<p>**Sets default for user preferences - only applies when persistent memory is reset (A12 On) during power-up.</p>			
FP	Filter Default Duration Set***	1	2 _
<p>***Sets default for user preferences - only applies when persistent memory is reset (A12 On) during power-up.</p>			
PURGE DURATION			
PP	Pump Purge Duration	3	1 2 5 t
<p><b>3</b> = 30 seconds; <b>1 - 5</b> = 1 - 5 minutes; <b>t</b> = 10 minutes</p>			
bP	Blower Purge Duration	5	1 2 3 4 6 t F
<p><b>5</b> = 5 seconds; <b>1</b> = 10 seconds; <b>2</b> = 20 seconds; <b>3</b> = 30 seconds;  <b>4</b> = 45 seconds; <b>6</b> = 60 seconds (1 minute); <b>t</b> = 2 minutes; <b>F</b> = 5 minutes</p>			
tP	Mister Purge Duration	5	1 2 3 4 6 t F
<p><b>5</b> = 5 seconds; <b>1</b> = 10 seconds; <b>2</b> = 20 seconds; <b>3</b> = 30 seconds;  <b>4</b> = 45 seconds; <b>6</b> = 60 seconds (1 minute); <b>t</b> = 2 minutes; <b>F</b> = 5 minutes</p>			
Ar	Air Valve	n	Y
<p><b>n</b> = Disabled; <b>Y</b> = Enabled on "alarm" relay</p>			

# Software Configuration Settings Continued

## REMOTE BUTTONS

<b>n1</b>	Remote Button 1 (Bank A)	<b>1</b> 2 3 4 5 6 b g F E o t d P n A U r O H 9 L 8 7
<b>n2</b>	Remote Button 2 (Bank A)	1 <b>2</b> 3 4 5 6 b g F E o t d P n A U r O H 9 L 8 7
<b>n3</b>	Remote Button 3 (Bank A)	1 2 <b>3</b> 4 5 6 b g F E o t d P n A U r O H 9 L 8 7
<b>n4</b>	Remote Button 4 (Bank A)	1 2 3 4 5 6 <b>b</b> g F E o t d P n A U r O H 9 L 8 7
<b>n5</b>	Remote Button 5 (Bank A)	1 2 3 4 5 6 b <b>g</b> F E o t d P n A U r O H 9 L 8 7
<b>n6</b>	Remote Button 6 (Bank A)	1 2 3 4 5 6 b g <b>F</b> E o t d P n A U r O H 9 L 8 7
<b>n7</b>	Remote Button 7 (Bank A)	1 2 3 4 5 6 b g F E <b>o</b> t d P n A U r O H 9 L 8 7
<b>n8</b>	Remote Button 8 (Bank A)	1 2 3 4 5 6 b g F E o <b>t</b> d P n A U r O H 9 L 8 7

**1-6** = Assigns Pump Number (Pump 1, Pump 2, etc); **b** = Blower; **g** = Spa Light; **F** = Fiber-Optic wheel/light; **E** = EitherLight; **o** = Option 1; **t** = Mister; **d** = CK Mode/Cool; **P** = CK Option/Heat; **n** = CK Intensity/TurboHt; **A** = ACD Aroma/Sound Mode Select; **U** = Button Disabled; **r** = Air Valve; **O** = Option 2; **H** = Option 3; **9** = Invert; **L** = Option 4; **8** = Stir; **7** = Option 5

### ROUND REMOTE

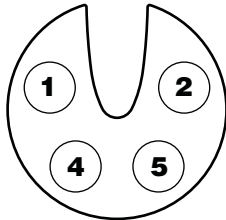

### DOLPHIN REMOTE

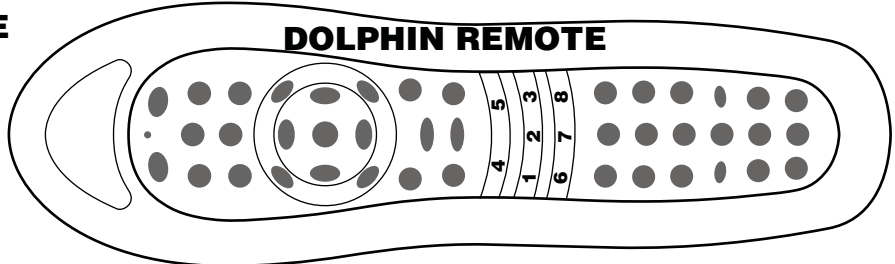

<b>H1</b>	Remote Button 1 (Bank B)	<b>1</b> 2 3 4 5 6 b g F E o t d P n A U r O H 9 L 8 7
<b>H2</b>	Remote Button 2 (Bank B)	1 <b>2</b> 3 4 5 6 b g F E o t d P n A U r O H 9 L 8 7
<b>H3</b>	Remote Button 3 (Bank B)	1 2 <b>3</b> 4 5 6 b g F E o t d P n A U r O H 9 L 8 7
<b>H4</b>	Remote Button 4 (Bank B)	1 2 3 4 5 6 <b>b</b> g F E o t d P n A U r O H 9 L 8 7
<b>H5</b>	Remote Button 5 (Bank B)	1 2 3 4 5 6 b <b>g</b> F E o t d P n A U r O H 9 L 8 7
<b>H6</b>	Remote Button 6 (Bank B)	1 2 3 4 5 6 b g <b>F</b> E o t d P n A U r O H 9 L 8 7
<b>H7</b>	Remote Button 7 (Bank B)	1 2 3 4 5 6 b g F E <b>o</b> t d P n A U r O H 9 L 8 7
<b>H8</b>	Remote Button 8 (Bank B)	1 2 3 4 5 6 b g F E o <b>t</b> d P n A U r O H 9 L 8 7

**1-6** = Assigns Pump Number (Pump 1, Pump 2, etc); **b** = Blower; **g** = Spa Light; **F** = Fiber-Optic wheel/light; **E** = EitherLight; **o** = Option 1; **t** = Mister; **d** = CK Mode/Cool; **P** = CK Option/Heat; **n** = CK Intensity/TurboHt; **A** = ACD Aroma/Sound Mode Select; **U** = Button Disabled; **r** = Air Valve; **O** = Option 2; **H** = Option 3; **9** = Invert; **L** = Option 4; **8** = Stir; **7** = Option 5

### ROUND REMOTE

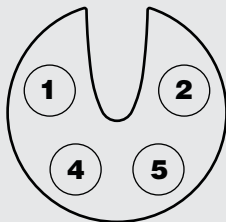

### DOLPHIN REMOTE

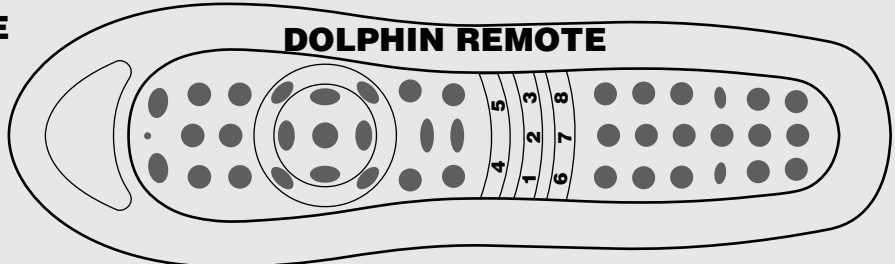

**d0** Remote Button Bank Select

**A** b \_  
**A** = Bank A; **b** = Bank B; **\_** = 1 DIP Switch

# Software Configuration Settings Continued

## ML90x SERIES BUTTONS

81	ML90x Custom Button 1	1 2 3 4 5 6 b g F E o t d P n A U r O H 9 L 8 7
82	ML90x Custom Button 2	1 2 3 4 5 6 b g F E o t d P n A U r O H 9 L 8 7
83	ML90x Custom Button 3	1 2 3 4 5 6 b g F E o t d P n A U r O H 9 L 8 7
84	ML90x Custom Button 4	1 2 3 4 5 6 b g F E o t d P n A U r O H 9 L 8 7
85	ML90x Custom Button 5	1 2 3 4 5 6 b g F E o t d P n A U r O H 9 L 8 7
86	ML90x Custom Button 6	1 2 3 4 5 6 b g F E o t d P n A U r O H 9 L 8 7
87	ML90x Custom Button 7	1 2 3 4 5 6 b g F E o t d P n A U r O H 9 L 8 7
88	ML90x Custom Button 8	1 2 3 4 5 6 b g F E o t d P n A U r O H 9 L 8 7

**1-6** = Assigns Pump Number (Pump 1, Pump 2, etc); **b** = Blower; **g** = Spa Light; **F** = Fiber-Optic wheel/light; **E** = EitherLight; **o** = Option 1; **t** = Mister; **d** = CK Mode/Cool; **P** = CK Option/Heat; **n** = CK Intensity/TurboHt; **A** = ACD Aroma/Sound Mode Select; **U** = Button Disabled; **r** = Air Valve; **O** = Option 2; **H** = Option 3; **9** = Invert; **L** = Option 4; **8** = Stir; **7** = Option 5

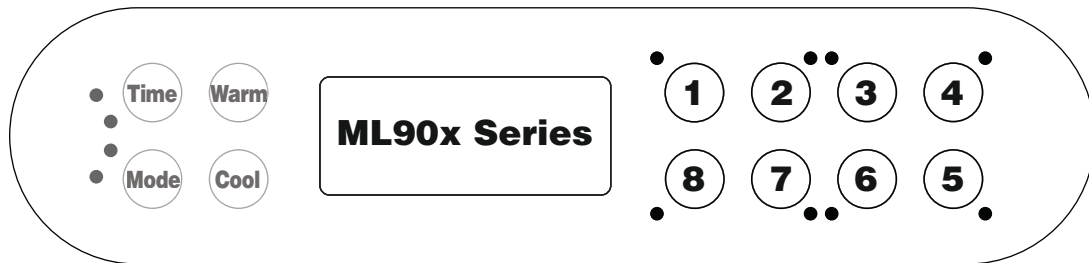

8C ML90x Custom Buttons Enable n **Y** \_  
**n** = Disabled; **Y** = Enabled; **\_** = 1 DIP Switch

## ML75x/MX75x SERIES BUTTONS

61	ML75x/MX75x Custom Button 1	1 2 3 4 5 6 b g F E o t d P n A U r O H 9 L 8 7
62	ML75x/MX75x Custom Button 2	1 2 3 4 5 6 b g F E o t d P n A U r O H 9 L 8 7
63	ML75x/MX75x Custom Button 3	1 2 3 4 5 6 b g F E o t d P n A U r O H 9 L 8 7
64	ML75x/MX75x Custom Button 4	1 2 3 4 5 6 b g F E o t d P n A U r O H 9 L 8 7
65	ML75x/MX75x Custom Button 5	1 2 3 4 5 6 b g F E o t d P n A U r O H 9 L 8 7
66	ML75x/MX75x Custom Button 6	1 2 3 4 5 6 b g F E o t d P n A U r O H 9 L 8 7

**1-6** = Assigns Pump Number (Pump 1, Pump 2, etc); **b** = Blower; **g** = Spa Light; **F** = Fiber-Optic wheel/light; **E** = EitherLight; **o** = Option 1; **t** = Mister; **d** = CK Mode/Cool; **P** = CK Option/Heat; **n** = CK Intensity/TurboHt; **A** = ACD Aroma/Sound Mode Select; **U** = Button Disabled; **r** = Air Valve; **O** = Option 2; **H** = Option 3; **9** = Invert; **L** = Option 4; **8** = Stir; **7** = Option 5

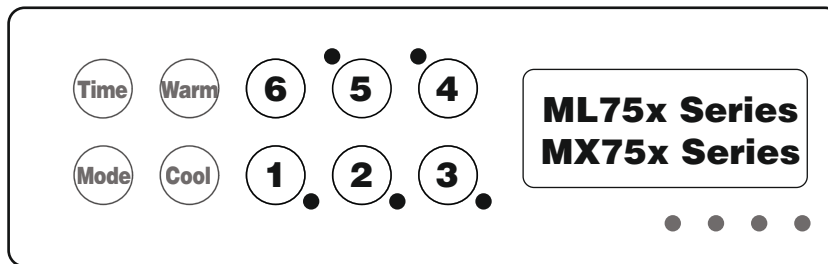

6C ML750/MX750 Custom Buttons Enable **n** Y \_  
**n** = Disabled; **Y** = Enabled; **\_** = 1 DIP Switch

# Software Configuration Settings Continued

## ML70X SERIES BUTTONS

41	ML70x Custom Button 1	1 2 3 4 5 6 b g F E o t d P n A U r O H 9 L 8 7
42	ML70x Custom Button 2	1 2 3 4 5 6 b g F E o t d P n A U r O H 9 L 8 7
43	ML70x Custom Button 3	1 2 3 4 5 6 b g F E o t d P n A U r O H 9 L 8 7
44	ML70x Custom Button 4	1 2 3 4 5 6 b g F E o t d P n A U r O H 9 L 8 7

**1-6** = Assigns Pump Number (Pump 1, Pump 2, etc); **b** = Blower; **g** = Spa Light; **F** = Fiber-Optic wheel/light; **E** = EitherLight; **o** = Option 1; **t** = Mister; **d** = CK Mode/Cool; **P** = CK Option/Heat; **n** = CK Intensity/TurboHt; **A** = ACD Aroma/Sound Mode Select; **U** = Button Disabled; **r** = Air Valve; **O** = Option 2; **H** = Option 3; **9** = Invert; **L** = Option 4; **8** = Stir; **7** = Option 5



4C	ML70x Custom Buttons Enable	n Y _ n = Disabled; Y = Enabled; _ = 1 DIP Switch
----	-----------------------------	--

## ML55X SERIES BUTTONS

51	ML55x Custom Button 1	1 2 3 4 5 6 b g F E o t d P n A U r O H 9 L 8 7
52	ML55x Custom Button 2	1 2 3 4 5 6 b g F E o t d P n A U r O H 9 L 8 7
53	ML55x Custom Button 3	1 2 3 4 5 6 b g F E o t d P n A U r O H 9 L 8 7
54	ML55x Custom Button 4	1 2 3 4 5 6 b g F E o t d P n A U r O H 9 L 8 7
55	ML55x Custom Button 5	1 2 3 4 5 6 b g F E o t d P n A U r O H 9 L 8 7

**1-6** = Assigns Pump Number (Pump 1, Pump 2, etc); **b** = Blower; **g** = Spa Light; **F** = Fiber-Optic wheel/light; **E** = EitherLight; **o** = Option 1; **t** = Mister; **d** = CK Mode/Cool; **P** = CK Option/Heat; **n** = CK Intensity/TurboHt; **A** = ACD Aroma/Sound Mode Select; **U** = Button Disabled; **r** = Air Valve; **O** = Option 2; **H** = Option 3; **9** = Invert; **L** = Option 4; **8** = Stir; **7** = Option 5

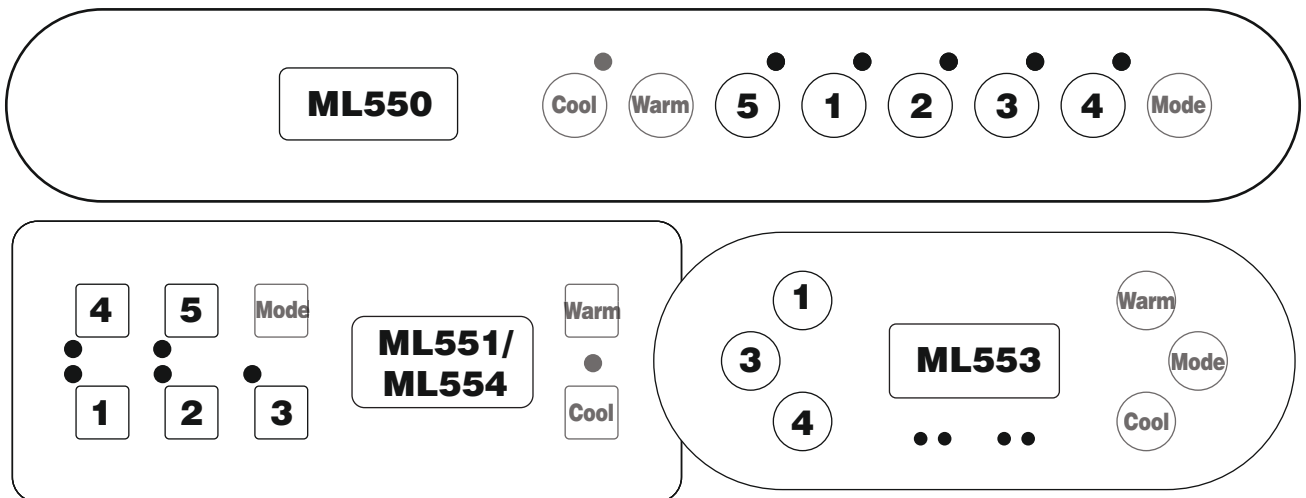

5C	ML55x Custom Buttons Enable	n Y _ n = Disabled; Y = Enabled; _ = 1 DIP Switch
----	-----------------------------	--



# Software Configuration Settings Continued

## ML40x/ML2xx SERIES BUTTONS

31	ML40x/ML2xx Custom Button 1	<input checked="" type="radio"/> 1 2 3 4 5 6 b g F E o t d P n A U r O H 9 L 8 7
32	ML40x/ML2xx Custom Button 2	<input checked="" type="radio"/> 1 2 3 4 5 6 b g F E o t d P n A U r O H 9 L 8 7
33	ML40x/ML2xx Custom Button 3	<input checked="" type="radio"/> 1 2 3 4 5 6 b g F E o t d P n A U r O H 9 L 8 7

**1-6** = Assigns Pump Number (Pump 1, Pump 2, etc); **b** = Blower; **g** = Spa Light; **F** = Fiber-Optic wheel/light; **E** = EitherLight; **o** = Option 1; **t** = Mister; **d** = CK Mode/Cool; **P** = CK Option/Heat; **n** = CK Intensity/TurboHt; **A** = ACD Aroma/Sound Mode Select; **U** = Button Disabled (**DO NOT USE**); **r** = Air Valve; **O** = Option 2; **H** = Option 3; **9** = Invert; **L** = Option 4; **8** = Stir; **7** = Option 5

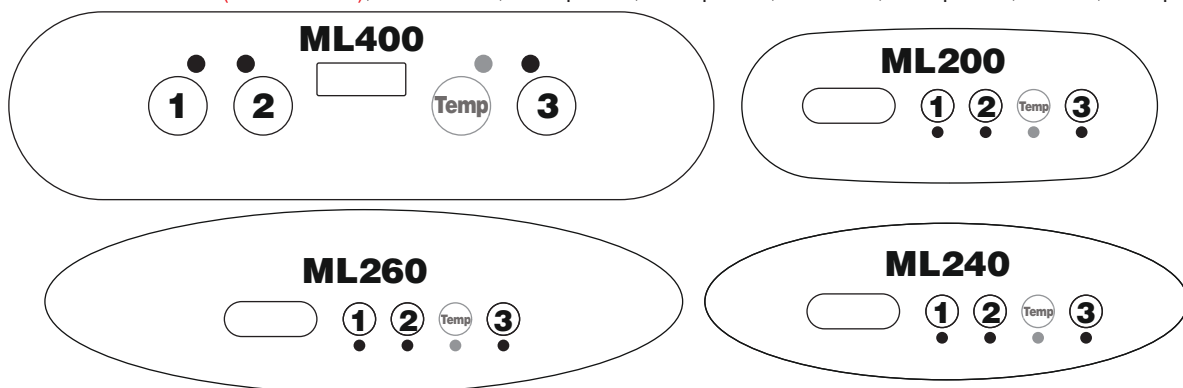

3E	ML40x/ML2xx Custom Buttons Enable	<input checked="" type="radio"/> Y _ n = Disabled; Y = Enabled; _ = 1 DIP Switch
5A	Special Amperage Rule*	<input checked="" type="radio"/> 1 2 3 4 1 = Blower off when 2nd high-speed pump on; 2 = Max 1 high-speed pump 3 = Max 2 high-speed pumps; 4 = Max 2 high-speed pumps + Blower off when 2nd high-speed pump on *Note: DIP A11 must be ON to use Special Amperage Rule.
HC	Heat Cool Feature	<input checked="" type="radio"/> Y _ n = Disabled; Y = Enabled; _ = 1 DIP Switch
CO	Color Kinetics	<input checked="" type="radio"/> Y n = Disabled; Y = Enabled
CD	ACD	<input checked="" type="radio"/> Y n = Disabled; Y = Enabled
DR	DR Mode	<input checked="" type="radio"/> Y n = Disabled; Y = Enabled
DE	Demo Mode	<input checked="" type="radio"/> Y n = Disabled; Y = Enabled
9C	Graphic Clock	<input checked="" type="radio"/> Y n = Disabled; Y = Enabled (Panel must be able to support this feature)
50	Sound Mode Select Enable**	<input checked="" type="radio"/> Y _ (Requires correct version of sound hardware) n = No; Y = User Preference; _ = 1 DIP Switch **Enables panel/aux/remote button access, if properly configured and User Preference access. Example: To select Sound Modes (see "So" below) by pressing Aux Button 1, configure setting "A1" to code assignment "A"
5o	Sound Mode Select	<input checked="" type="radio"/> A b c n (Values dependent on sound hardware used) A = Sound choice 1; b = Sound choice 2; c = Sound choice 3; n = No sounds
9F	GFCI Test Enable	<input checked="" type="radio"/> 1 2 3 4 5 6 7 n = Disabled; 1 = Auto after 1 day; 2 = Auto after 2 days; 3 = Auto after 3 days; 4 = Auto after 4 days; 5 = Auto after 5 days; 6 = Auto after 6 days; 7 = Auto after 7 days

# Ozone Connections

**Ozone Connector Voltage:** The EL circuit board is factory configured to deliver a preset voltage (120V or 240V) to the on-board ozone connector (J4). See the ratings table on the wiring diagram attached to the cover of the enclosure for the configured voltage. For 240V output W13 connects to Red AC and for 120V output W13 connects to White AC.

The voltage to the ozone connector can be changed in the field if required. W13 just needs to be set for the required voltage.

**Balboa Ozone Generator:** If the board is set up to operate a 120V ozone generator, the connector on the ozone generator is likely to be configured correctly, but should be compared to the illustration below.

If a 240V ozone generator is required, be sure the red wire in the ozone cord is positioned in the connector next to the green ground wire as described below.

*Note: A special tool is required to remove the pins from the connector body once they are snapped in place. Check with your Balboa Account Manager for information on purchasing a pin-removal tool.*

## Balboa Ozone connector configuration for 120V 60Hz

- Line - Black conductor
- Use this slot for the leftover Red conductor
- Common - Install the White conductor here for 120V ozone
- Ground (Green) conductor

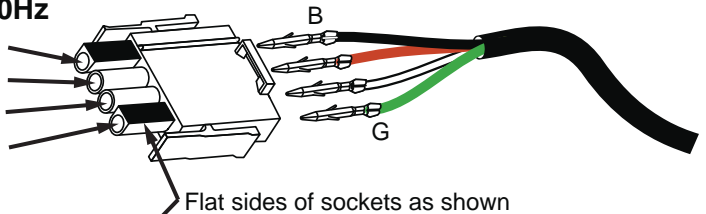

## Balboa Ozone connector configuration for 240V 60Hz

- Line - Black conductor
- Use this slot for the leftover White conductor
- Common - Install the Red conductor here for 240V ozone
- Ground (Green) conductor

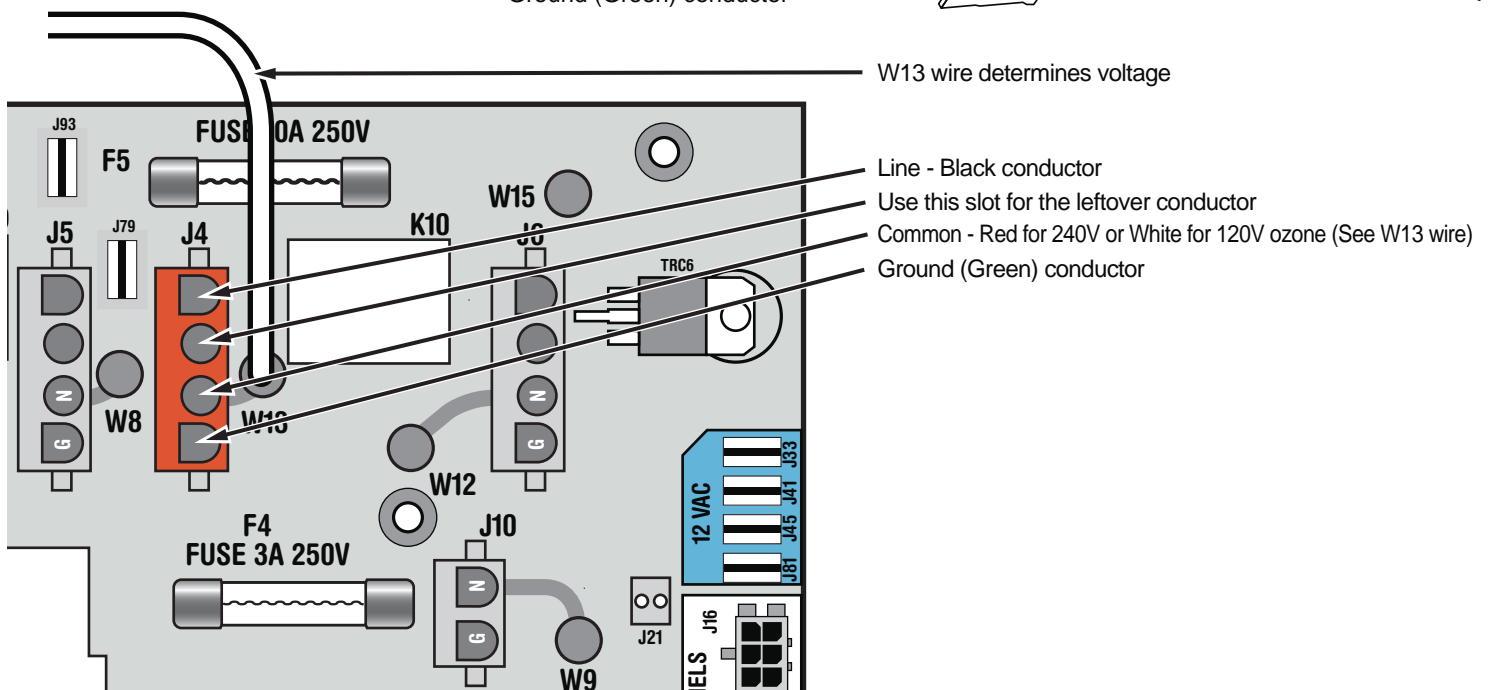
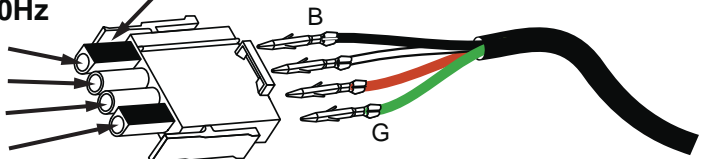

# Panel Configurations

## SETUPS 1

Note: RTC jumper (J91) on Main PCBA must be OFF (1 pin only)



ML900

PN 54589 with Overlay PN 11806

- Connects to Main Panel terminal J70, J71, J72, or J73

## SETUP 2



MLM990S

PN 54527-02 with Overlay PN 11810

- Connects to ADCM Splitter

## AUXILIARY



AX40 (Optional on Setup 1 – REQUIRED on Setup 2)

PN 55487 with Overlay PN 11823

- Connects to Aux Panel terminal J31, J34, J40, or J16



AX10A3 (Optional on Setup 1)

PN 52765 with Overlay PN 40107\_B

- Connects to Aux Panel terminal J31, J34, J40, or J16